

Magnetic Compass SH-165A2 / SH-165A2-1

〈Magnetic Compass Reflector Type SH-165A2〉

Magnetic Compass Reflector Type is designed to reflect the card image of compass bowl in a mirror through reflecting pipe.

The compass card floating in a bowl is lightened by under lamp.

For ease of reading, the reflected image of compass card is magnified by lens in reflecting pipe.

〈Magnetic Compass Remote Display Type SH-165A2-1〉

Instead of reflecting pipe, SH-165A2-1 applies Universal Display UD-10 as heading indicator, which contributes to simplifying design and saving space of wheel house.

Complied with IMO requirements, and also with "Wheel Marking".

Compliance with

- IMO A.382 (X), ISO 25862
- Marine Equipment Directive (MED)
- Japanese Government Certificate No.4294

Specifications

Standard color	Light gray
Weight	Compass stand 90kg
	Compass bowl 11.3kg

Heading indication method



SH-165A2
Reflecting Pipe



SH-165A2-1
Universal Display

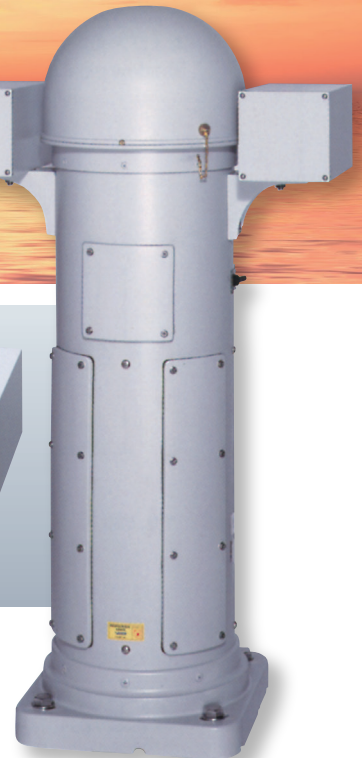

Magnetic Compass SH-165A2 / SH-165A2-1

Component

Compass bowl (HB-165A-5)	1	Diameter of card 165 mm
Compass stand	1	
Helmet	1	
Reflecting pipe (SH-165A2 only)	1	Standard length 500, 630, 760, 890
UD-10 (SH-165A2-1 only)		
Shadow pin	1 set	3 pieces and adapter
Correcting tool	1 set	• Correcting magnet 16 pieces in case
		• Quadrantal corrector 12 sheets in case
		• Flinder's bar 5 pieces in case

Spare parts (in case)

Electric bulb DC24 V 40 W	5	1 in use
---------------------------	---	----------

Options

● Control panel (Wall mount type or flush type)

● Azimuth circle



● Azimuth mirror

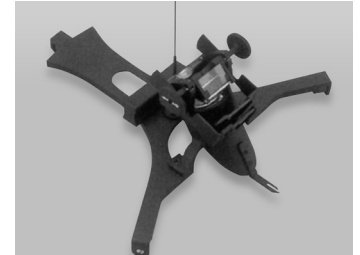

● Course magnifier



Dimensions (SH-165A2)

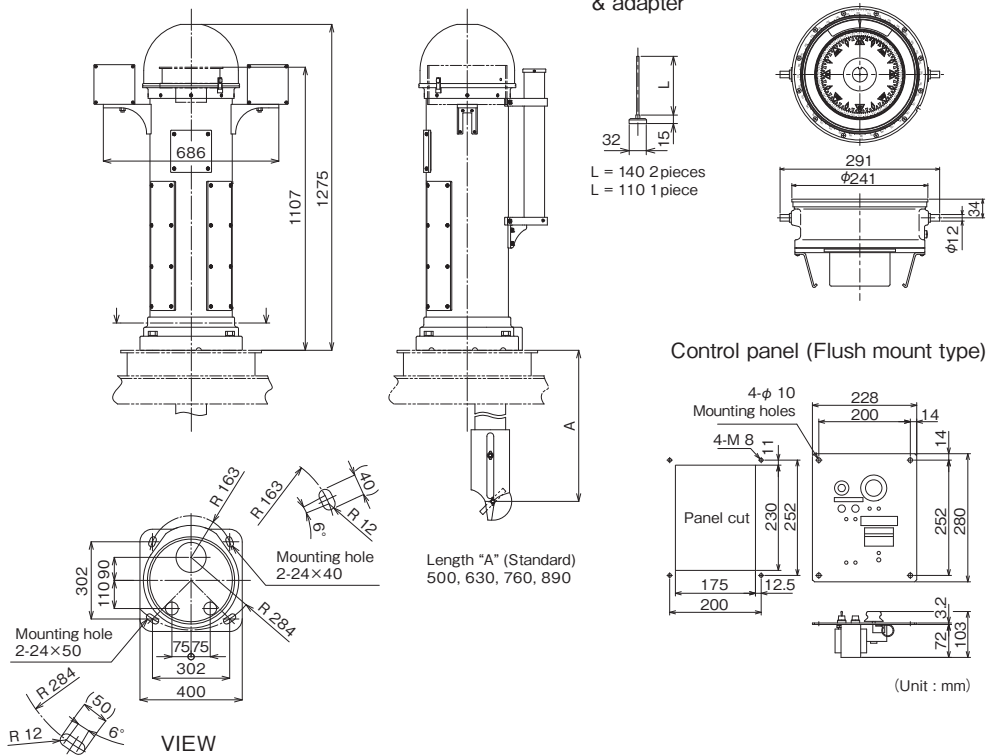

Design and specifications are subject to change without prior notice, and without any obligation on the part of the manufacturer.

CAUTION Before operating this equipment, you should first thoroughly read the operator's manual.

TOKYO KEIKI

TOKYO KEIKI INC.

Marine Systems Company

Head Office

2-16-46, Minami-Kamata, Ohta-ku, Tokyo 144-8551 JAPAN
TEL. +81-3-3737-8611 FAX. +81-3-3737-8663

TOKYO KEIKI (SHANGHAI) CO., LTD.

C-1407, Orient International Plaza, No.85 Lou Shan Guan Rd., Shanghai 200336. CHINA
TEL. +86-21-3223-1252 FAX. +86-21-6278-7667

TOKYO KEIKI U.S.A., INC.

3452 East.Foothill Boulevard.Suite 420 Pasadena, CA 91107 U.S.A.
TEL. +1-626-403-1500 FAX. +1-626-403-7400

<https://www.tokyokeiki.jp/e/products/marine/>