

NSafe™-Hull

Highly Ductile Steel Plates for Shipbuilding

**Steel for Enhancing Ship
Collision Safety**



www.nipponsteel.com

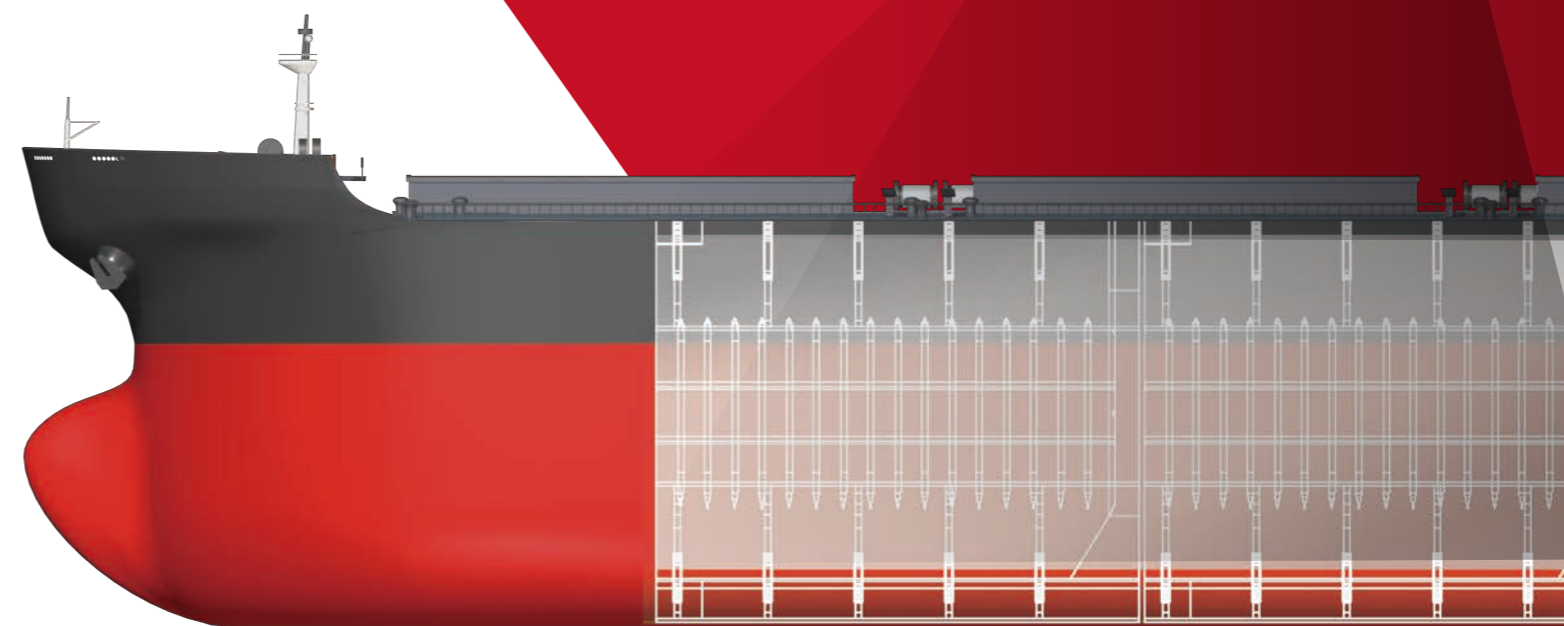

Notice: While every effort has been made to ensure the accuracy of the information contained within this publication, the use of the information is at the reader's risk and no warranty is implied or expressed by NIPPON STEEL CORPORATION with respect to the use of the information contained herein. The information in this publication is subject to change or modification without notice. Please contact the NIPPON STEEL CORPORATION office for the latest information.

Please refrain from unauthorized reproduction or copying of the contents of this publication.

The names of our products and services shown in this publication are trademarks or registered trademarks of NIPPON STEEL CORPORATION, affiliated companies, or third parties granting rights to NIPPON STEEL CORPORATION or affiliated companies. Other product or service names shown may be trademarks or registered trademarks of their respective owners.

NIPPON STEEL CORPORATION

2-6-1 Marunouchi, Chiyoda-ku, Tokyo 100-8071, Japan
Tel: +81-3-6867-4111

NSafe™-Hull
A103en_01_201904f
© 2019 NIPPON STEEL CORPORATION



Highly Ductile Steel Plate—NSafe-Hull—Debuts as an Advanced Shipbuilding Plate.

Once a ship collides or grounds, its hull may rupture causing economically and environmentally serious damages. In order to prevent such accidents, safety rules and measures have already been enforced, e.g., since 1992 with the implementation of obligatory construction of double-hull of tankers by the IMO (International Maritime Organization).

Aiming to further enhance collision safety, NIPPON STEEL has developed a highly ductile steel plates, "NSafe-Hull". Even in cases when a ship is collided, the impact of the collision can be mitigated if NSafe-Hull is adopted as the structural materials for the ship's hull and it can prevent spreading the damage in hull structures.

NSafe-Hull—NIPPON STEEL's advanced steel plate—enhances ship collision safety to the maximum and contributes to safer marine transportation



Nearly tripling the capacity of a ship to absorb collision energy and nearly doubling the critical striking ship speed for penetration* over conventional steel plates. NSafe-Hull steel plates have been developed by novel concepts and advanced technologies unique to NIPPON STEEL.

NSafe-Hull is a highly ductile steel plates in which the ductility has been improved by the optimum use of NIPPON STEEL's original chemical composition design and crystalline size-order microstructural control. When an impact force is applied to a ship, it is absorbed by denting of the plates themselves. In the NSafe-Hull, the capacity to absorb collision energy has been improved three times over that of conventional plates. The critical striking ship speed is twice that of conventional plates as well. Consequently the high ductility offered by NSafe-Hull can increase the period in which cracks and ruptures occur in.

For example, even if a crude oil tanker is in an accident, NSafe-Hull can prevent the oil spill into the sea. NSafe-Hull contributes toward safer and securer marine transport of tankers, cargo ships and other types of ships.

*Critical striking ship speed: The maximum speed at which penetration does not occur after collision

The advantages in ship-owner expected

A ship is an important asset to its owner. The application of NSafe-Hull can minimize the spread of damage and loss caused by an unexpected collision and thereby mitigates a ship owner's burden attributable to a collision. Major advantages in ship-owners offered by the use of NSafe-Hull are:

- ① Greater reduction of damages caused by accidents by high ductility of the steels
- ② Shipbuilding operations identical to those of conventional steels due to chemical composition design for high weldability
- ③ Profitable resale of ship as a vessel of high added value
- ④ Corporate social responsibility contributes to environmental preservation

Application Records of NSafe-Hull



Ship name: Orange Phoenix
Completion: Oct. 2014
Length: 299.94 m
Breadth: 50 m
Dead weight: 206,600 DWT

Many ships have already adopted
High performance is confirmed by ship collision simulation.

NSafe-Hull has already been applied in the world's first shipbuilding application. It has been adopted by 12 vessels so far, and the shipment volume exceeds 20,000 tons. Collision simulations to confirm the applied effects of NSafe-Hull were carried out at the National Maritime Research Institute, Japan, which is the world-renowned centre for its analysis technologies.

NIPPON STEEL Values Applicability of NSafe-Hull to a Wide Variety of Ships.

In the field of medium and heavy steel plates for shipbuilding, NIPPON STEEL offers diverse kinds of high-performance steel plates in addition to conventional plates. NSafe-Hull, among others, is the most-advanced shipbuilding plate. You only need replacing conventional plates with NSafe-Hull to enhance ship collision safety –This is NIPPON STEEL’s way starting at the research and development stage.

Because there are no changes in ship design and manufacturing technologies, NSafe-Hull can be applied in a wider range of shipbuilding. High quality Made-in-Japan steel plates can be applied with no considerable cost increase. Their applications will differentiate lead your precious products from others built by conventional shipbuilders.

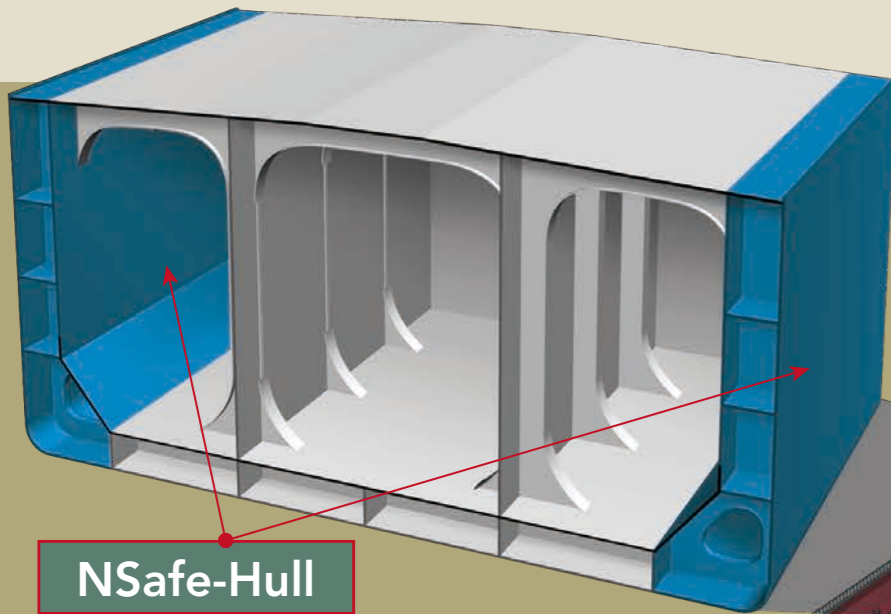

NSafe-Hull

TMCP Steels

With TMCP (thermomechanical control process) technology, steel with a lower carbon equivalent and higher strength can be produced compared to conventional steels. TMCP steels offer high strength, toughness and high weldability. They can be fabricated with large heat-input welding. They can therefore contribute to improved shipbuilding efficiency. Applications: Steel plates for entire ship hull structures

High arrest teel (YP47 km steel)

YP47 km steel is a steel material compatible with arrestability (toughness) and strength, in response to the enlargement of container ships. Even when brittle cracks occur in the hull, it is possible to stop the cracks and to realize the safety of the ship at a higher level.

FCA™ Steels

FCA (fatigue crack arrester) steels has improved fatigue strength in weld joints. If by any chance a fatigue crack occurs, the steel can reduce the propagation rate. Applications: Longitudinal sections (frames for double-wall bottom), hutch corner sections

S-TEN™

Sulfuric Acid and Hydrochloric Acid Dew-point Corrosion-resistant Steel
S-TEN exhibits the best resistance to sulfuric acid and hydrochloric acid dew-point corrosion found in the flue-gas treatment equipment used with coal-fired boilers, waste incineration plants, etc.

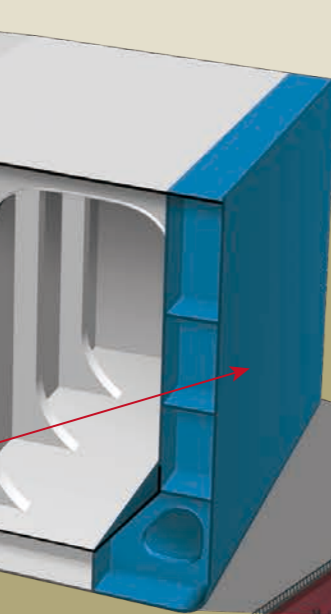

NSGP™-1

Pitting corrosion occurring in bottom plate sections of crude oil tanks can be reduced by using NSGP (NIPPON STEEL Green Protect)-1 steel. If this steel is applied in an unpainted state, shipbuilding and maintenance costs can be reduced.

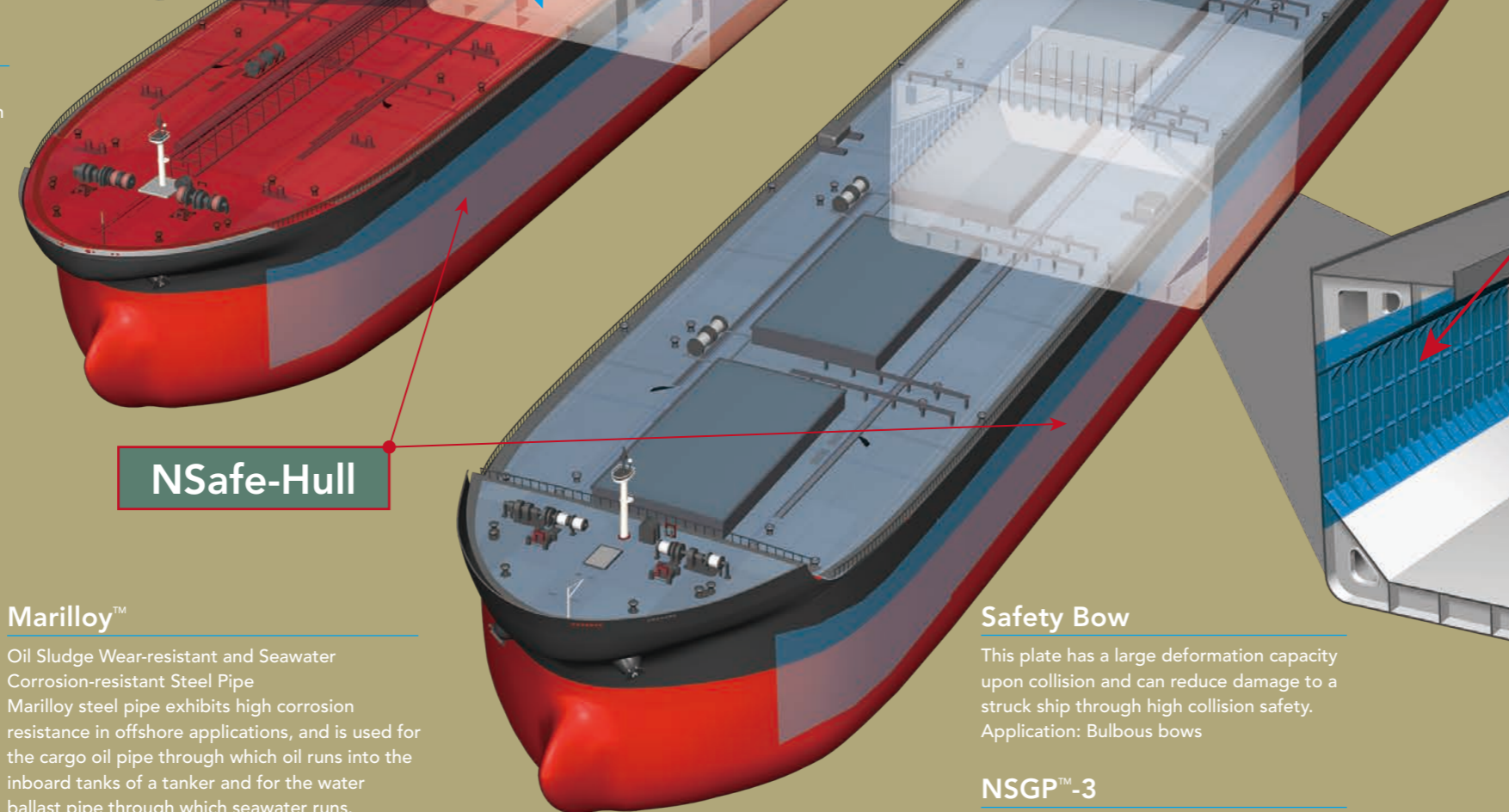

NSafe-Hull

Marilloy™

Oil Sludge Wear-resistant and Seawater Corrosion-resistant Steel Pipe
Marilloy steel pipe exhibits high corrosion resistance in offshore applications, and is used for the cargo oil pipe through which oil runs into the inboard tanks of a tanker and for the water ballast pipe through which seawater runs.

NSGP™-2

Corrosion occurring on ceiling parts of crude oil tanks can be reduced by using NSPG (NIPPON STEEL Green Protect)-2 steel. If this steel is applied in an unpainted state, shipbuilding and maintenance costs can be reduced.

Highly ductile steel plates developed by original chemical composition design

NSafe-Hull

Study on ship collision has led to the development of NSafe-Hull, a new plate that is suitable for a wider range of applications, including cargo hold hull and fuel oil tanks. NSafe-Hull’s high ductility is achieved by the original chemical composition design and crystalline size-order microstructural control. Its workability (shearing, bending, welding and painting) is identical to those of conventional steels. The safety and security only NSafe-Hull provides is now available to users.

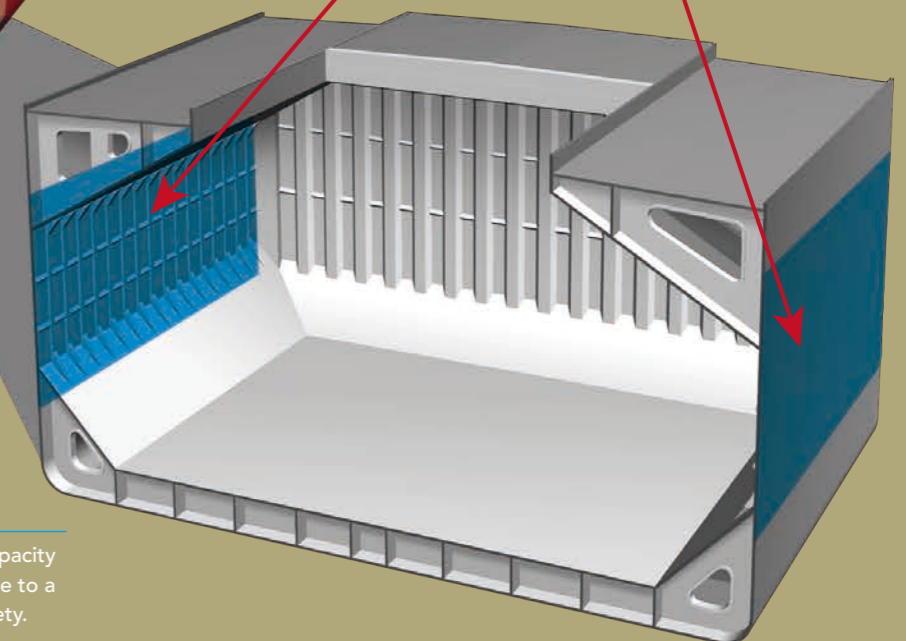

Safety Bow

This plate has a large deformation capacity upon collision and can reduce damage to a struck ship through high collision safety. Application: Bulbous bows

NSGP™-3

Coming soon on the market

The Top Ship Brand with Evaluated Performance



The performances of NSafe-Hull have been proved at the National Maritime Research Institute, Japan, which is known as the world-renowned centre for its ship collision analysis technologies.

NSafe-Hull is the Made-in-Japan product that was developed in an integrated process extending from R&D to production and is based on the sublime concept that hull ruptures should not occur even in a collision. The application of NSafe-Hull will prove the high structural reliability and safety of ships and will certainly improve the overall reputation of ships.

We are confident to say that ship design with NSafe-Hull will become the worldwide de facto standard in shipbuilding.

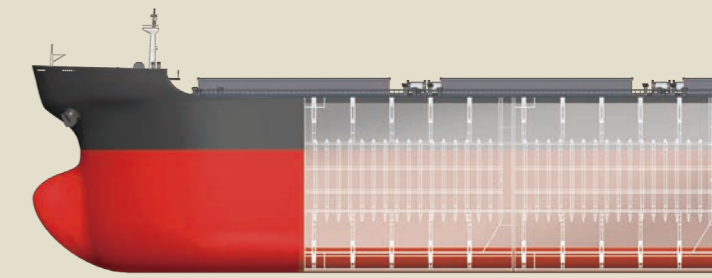

Penetrating rupture-free performance even in a 12-knot collision NSafe-Hull

The stated performance of NSafe-Hull has been proved by collision simulations at the National Maritime Research Institute, Japan. The simulation results demonstrate that the penetration does not occur in the inner hull of double-hull structure of a crude oil tanker employing NSafe-Hull in the case of the maximum strike speed of 12 knots. In the case of the bulk carrier with NSafe-Hull, simulation results confirmed that the penetration does not occur in the single hull structure at the maximum speed of 5 knots. NSafe-Hull is assessed to be a shipbuilding steel plate that can prevent oil spill that might otherwise cause huge environmental damages, as well as massive cargo discharge and even human injury. NSafe-Hull leads another evolutionary step in the enhancement of maritime safety.

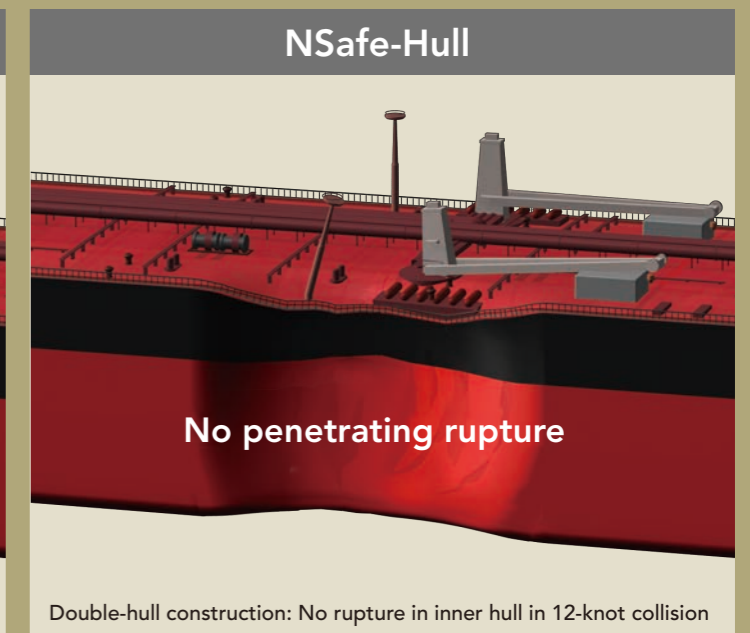
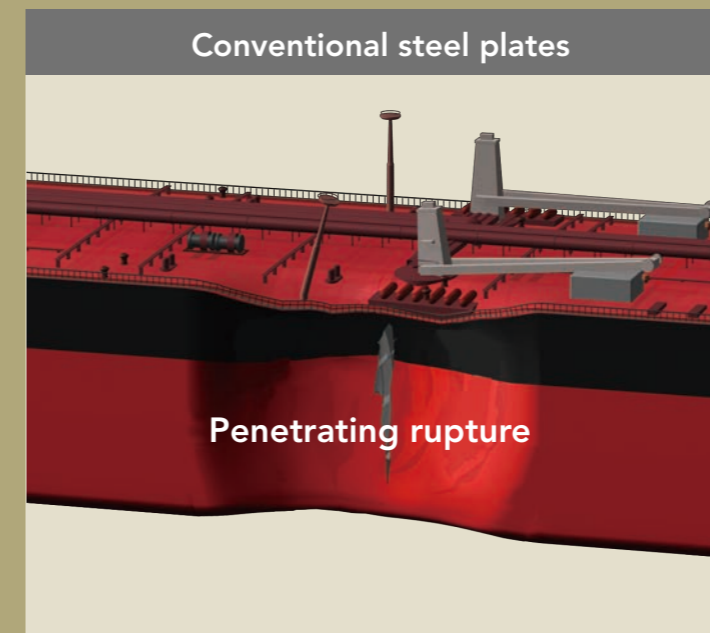
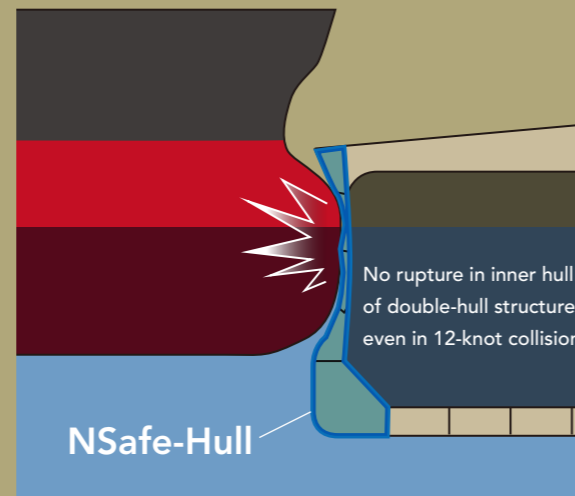

Double-hull construction: No rupture in inner hull in 12-knot collision

*Figures: Schematic image of simulation results

Absorbed Energy by Struck Ship, Normalised

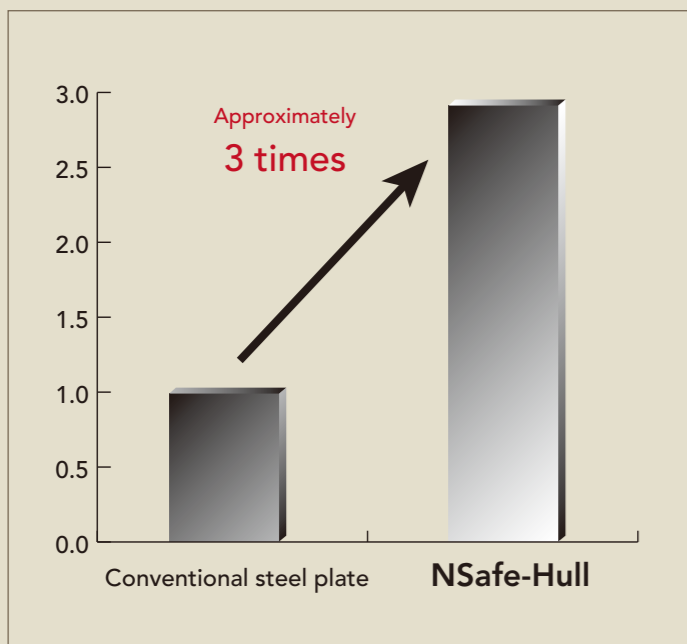

Absorbed energy by struck ship, normalised by value of case with conventional steel.

Critical Striking Ship Speed for Penetration, Normalised

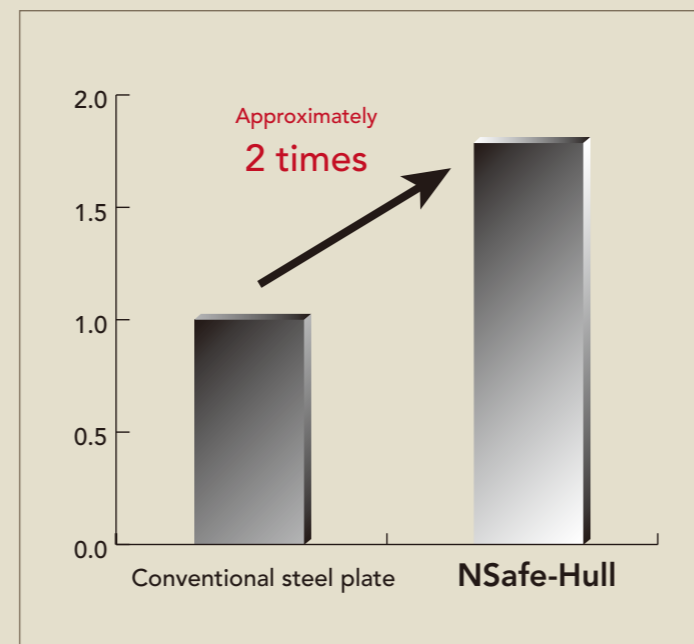

Critical striking ship speed for penetration, normalised by value of case with conventional steel.

Expected Advantages of Highly Ductile Steel Plate (NSafe-Hull) as Structural Members

	Application sections	Members	Advantages
Bulk carriers	Cargo hold single hull sections	Side shell plating Hold frames Side longitudinal frames	Prevention of flooded cargo holds Protection of cargo Prevention of penetration by loading machine grab impacts(I)
	Fuel oil tanks (top-side tank sections)	Side shell platings Top-side tank bottom platings Fuel oil tank longitudinal bulkheads Longitudinal stiffeners	Prevention of oil spill Prevention of penetration by loading machine grab impacts(I)
	Fuel oil tanks (engine room)	Side shell platings Fuel tank longitudinal bulkheads	Prevention of oil spill
Tankers	Cargo hold hull sections	Outer hull platings Outer hull longitudinal stiffeners	Prevention of oil spill
	Cargo hold inner hull sections	Inner hull platings Inner hull longitudinal stiffeners	Prevention of oil spill
	Fuel oil tank (engine room)	Hull platings Fuel oil tank longitudinal bulkheads	Prevention of oil spill