

Digital servoproportionals with on-board axis card

direct, single solenoid, sleeve execution, with LVDT transducer and zero spool overlap

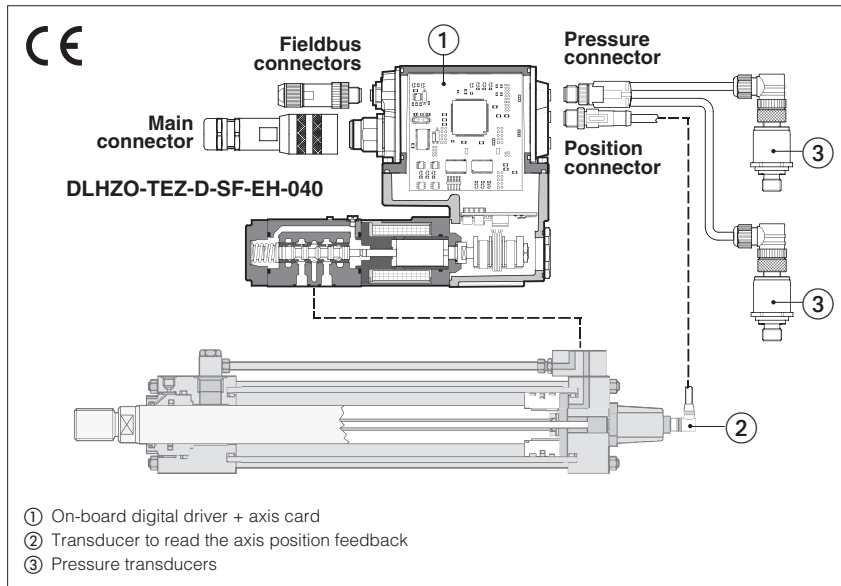

DLHZO-TEZ, DLKZOR-TEZ

Digital servoproportional directional valves, direct, single solenoid, sleeve execution, with on-board digital driver + axis card, LVDT position transducer and zero spool overlap for best performances in any position closed loop controls of linear or rotative hydraulic actuator. The sleeve execution grants high regulation accuracy and response sensitivity. The controlled actuator has to be equipped with transducer (analog, potentiometer, SSI or Encoder) to read the axis position feedback. The valve can be operated via an external reference signal or automatic cycle, see section [2].

Alternated P/Q controls, see [3]:

SF, SL = alternated force control added to the basic position one

Safety options TÜV certified, see [8]:

U = safe double power supply
K = safe on/off signals

DLHZO: Size: 06 -ISO 4401 Max flow: 70 l/min Max pressure: 350 bar	DLKZOR: Size: 10 -ISO 4401 Max flow: 160 l/min Max pressure: 315 bar
---	---

1 MODEL CODE

DLHZO	-	TEZ	-	D	-	SN	-	NP	-	0	-	40	-	L	7	3	/	*	/	*
--------------	---	------------	---	----------	---	-----------	---	-----------	---	----------	---	-----------	---	----------	----------	----------	---	---	---	---

Servoproportional directional valves, direct
DLHZO = size 06
DLKZOR = size 10

TEZ = on-board digital driver + axis card, one LVDT transducer

Position transducer type:
A = Analog (standard, potentiometer)
D = Digital (SSI, Encoder)

Alternated P/Q controls:
SN = none
SF = force control (2 pressure transducers)
SL = force control (1 load cell)

Fieldbus interface, USB port always present:
NP = Not Present
BC = CANopen
BP = PROFIBUS DP
EH = EtherCAT
EW = POWERLINK
EI = EtherNet/IP
EP = PROFINET RT/IRT

Valve size ISO 4401: **0** = 06 **1** = 10

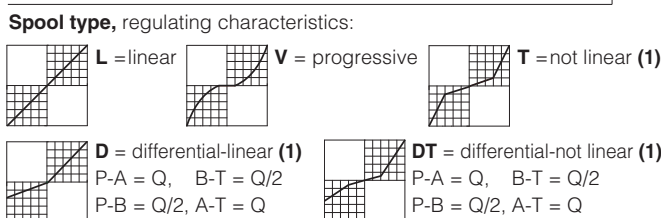
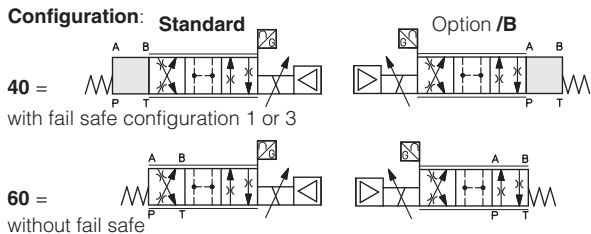

Seals material, see section [12]:
 - = NBR
PE = FKM
BT = NBR low temp.

Hydraulic options (2):
B = solenoid with on-board digital driver + axis card and position transducer at side of port A
Y = external drain

Electronics options (2):
C = current feedback for analog position and pressure transducers 4÷20mA (omit for std voltage ±10Vdc)
I = current reference input and monitor 4÷20mA (omit for std voltage ±10Vdc)

Safety options TÜV certified (2):
U = safe double power supply
K = safe on/off signals
 See section [8]



Fail safe configuration, see section [14]:



Note: select **1** for configuration **60** even without fail safe

Spool size: 0(L) 1(L) 1(V) 3(L) 3(T) 3(V) 5(L,T) 7(L,T,V,D,DT)

DLHZO =	4	7	8	14	-	20	28	40
DLKZOR =	-	-	-	60	60	-	-	100

Nominal flow (l/min) at Δp 70bar P-T

(1) Not available for configuration 60 (2) For possible combined options, see section [17]

2 POSITION CONTROL

2.1 External reference signal

Axis card controls in closed loop the actuator position according to a reference signal from the machine central unit.

Position profile can be managed in two ways (software selectable):

- Without trajectory generation **(a)**: the axis card receives from the machine central unit the reference signal and follows it at any given instant
- With trajectory generation **(b)**: the axis card receives from the machine central unit just the final target position and internally generates a position profile limiting acceleration, velocity and deceleration

The reference signal can be software selected between Analog reference **(c)** and Fieldbus reference **(d)**.

Refer to the axis card user manual for further details on position control features.

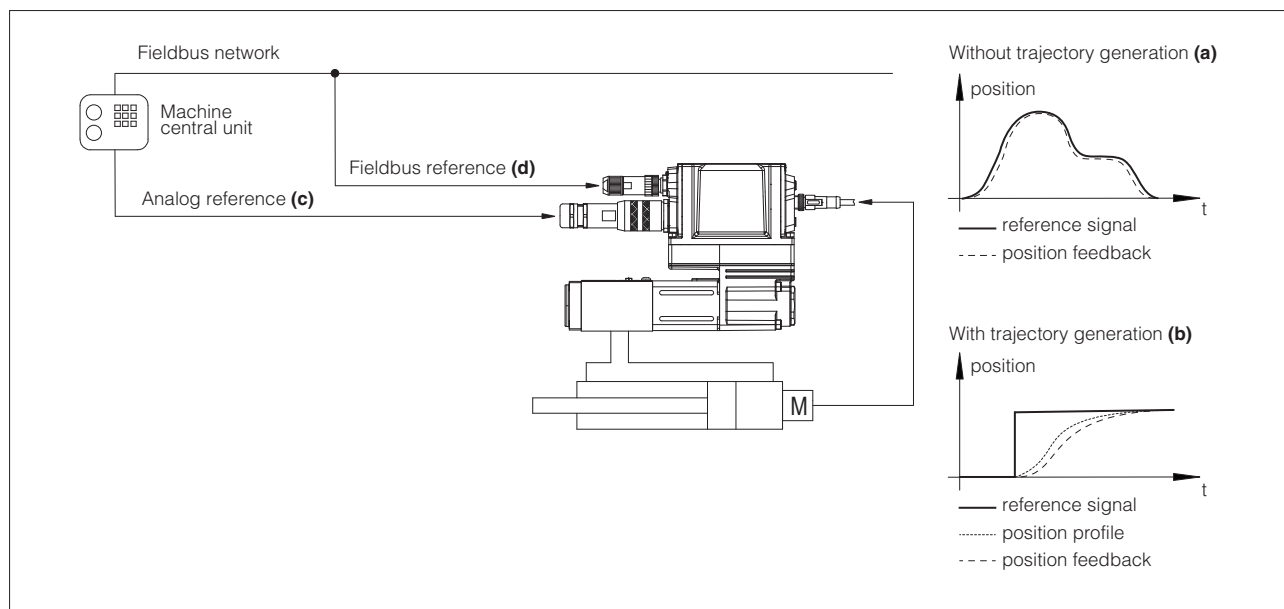

2.2 Automatic cycle

Axis card controls in closed loop the actuator position according to an internally generated automatic cycle: only start, stop and switch-over commands are required from the machine electronic central unit by means On-off commands **(e)** or Fieldbus commands **(f)**.

Atos PC software allows to realize an automatic cycle according to the application requirements. Refer to the axis card user manual for further details on automatic cycle features.

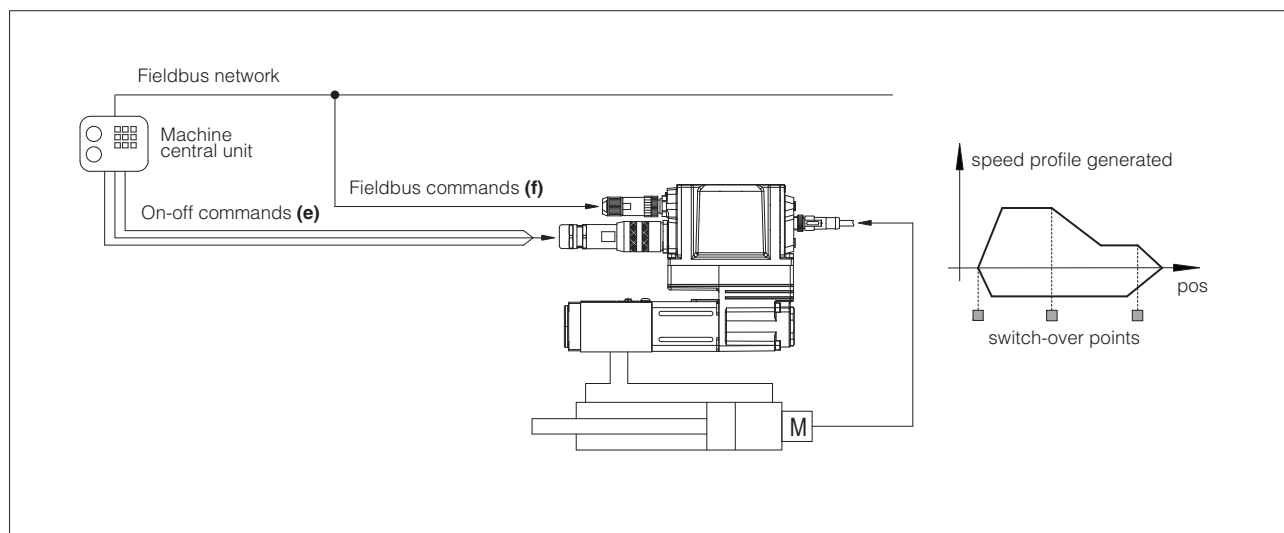

3 ALTERNATED POSITION / FORCE CONTROL

SF and **SL** controls add the alternated force closed loop control to the actuator standard position control. Pressure or force remote transducers have to be installed on the actuator and interfaced to the valve, see below functional schemes.

The position/force controls are operated according to two separate reference signals and a dedicated algorithm automatically selects which control is active time by time.

The dynamics of the switching between the two controls can be regulated thanks to specific software setting, in order to avoid instability and vibrations.

Position control is active (see phase ① and ③ at side) when the actuator force is lower than the relevant reference signal - the valve controls the actuator position by closed-loop regulation.

Force control is active (see phase ② and ④ at side) when the actuator actual force, measured by remote transducers, grows up to the relevant reference signal - the axis card reduces the valve's regulation in order to limit the actuator force; if the force tends to decrease under its reference signal, the position control returns active.

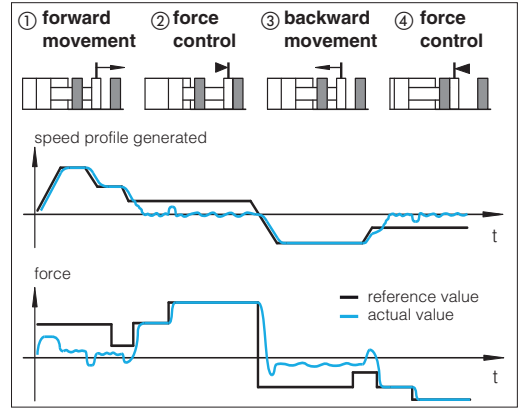

Alternated control configurations

SF	SL
<p>two remote pressure transducers have to be installed on the actuator's ports; the actuator force is calculated by the pressure feedbacks ($P_a - P_b$)</p>	<p>one load cell transducer has to be installed between the actuator and the controlled load</p>
<p>T valve spool transducer</p>	<p>M actuator position transducer</p>
<p>P pressure transducer</p>	<p>L load cell</p>

SF – position/force control

Adds force control to standard position control and permits to limit the max force in two directions controlling in closed loop the delta pressure acting on both sides of the hydraulic actuator. Two pressure transducers have to be installed on A and B hydraulic lines.

SL – position/force control

Adds force control to standard position control and permits to limit the max force in one or two directions controlling in closed loop the force performed by the hydraulic actuator. A load cell has to be installed on the hydraulic actuator.

General Notes:

- auxiliary check valves are recommended in case of specific hydraulic configuration requirements in absence of power supply or fault
- Atos technical office is available for additional evaluations related to specific applications

4 GENERAL NOTES

Atos digital proportionals valves are CE marked according to the applicable directives (e.g. Immunity and Emission EMC Directive). Installation, wirings and start-up procedures must be performed according to the general prescriptions shown in tech table **FS900** and in the user manuals included in the Z-SW-* programming software.

5 VALVE SETTINGS AND PROGRAMMING TOOLS

Valve's functional parameters and configurations, can be easily set and optimized using Atos Z-SW programming software connected via USB port to the axis card (see table **FS900**). For fieldbus versions, the software permits valve's parameterization through USB port also if the axis card is connected to the central machine unit via fieldbus.

Z-SW-FULL support:	NP (USB)	PS (Serial)	
	BC (CANopen)	BP (PROFIBUS DP)	EH (EtherCAT)
	EW (POWERLINK)	EI (EtherNet/IP)	EP (PROFINET)

Note: Z-SW programming software supports valves with option SF, SL for alternated control

WARNING: axis card USB port is not isolated! For E-C-SB-USB/M12 cable, the use of isolator adapter is highly recommended for PC protection (see tech table **GS500**)

WARNING: see tech table **GS500** for the list of countries where the Bluetooth adapter has been approved

USB or Bluetooth connection

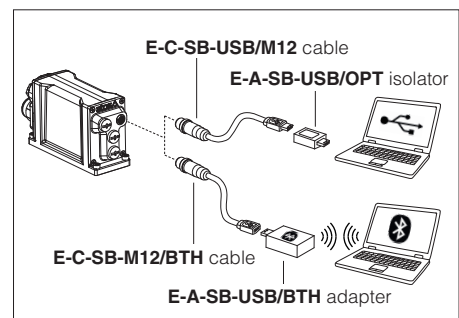

6 SMART TUNING

Smart tuning allows to adjust the valve dynamic response in order to match different performance requirements.

Note: the smart tuning setting affects the **dynamics of the valve spool control** and indirectly allows to change the axis response. Anyway the final dynamics of the axis position closed loop control is regulated by specific parameters

The valve is provided with 3 factory settings for the spool control:

- **dynamic** fast response time and high sensitivity for best dynamic performances. Default factory setting for directional valves
- **balanced** average response time and sensitivity suitable for major applications
- **smooth** attenuated response time and sensitivity to improve control stability in critical applications or in environments with electrical disturbances

Smart tuning setting can be switched from Dynamic (default) to Balanced or Smooth via software or fieldbus; if requested, performances can be further customized directly tuning each single control parameter. For details consult related manuals Z-MAN-RI-*, see section [26](#).

For Response time and Bode diagrams see section [13](#).

7 FIELDBUS - see tech. table GS510

Fieldbus allows valve direct communication with machine control unit for digital reference, valve diagnostics and settings. These execution allow to operate the valves through fieldbus or analog signals available on the main connector.

8 SAFETY OPTIONS

Atos range of proportional directional valves, provides functional safety options **/U** and **/K**, designed to accomplish a safety function, intended to reduce the risk in process control systems.

They are **TÜV certified** in compliance to **IEC 61508 up to SIL 3 and ISO 13849 up to category 4, PL e**



Safe double power supply, option **/U**: the axis card has separate power supplies for logic and solenoids. The safe condition is reached by cutting the electrical supply to solenoids, while electronics remains active for monitoring functions and fieldbus communication, see tech table **FY100**

Safety function via on/off signals, option **/K**: upon a disable command, the axis card checks the spool position and it provides on-off acknowledgement signal only when the valve is in safe condition, see tech table **FY200**

9 GENERAL CHARACTERISTICS

Assembly position	Any position
Subplate surface finishing to ISO 4401	Acceptable roughness index: Ra ≤0,8, recommended Ra 0,4 – Flatness ratio 0,01/100
MTTFd valves according to EN ISO 13849	150 years, see technical table P007
Ambient temperature range	Standard = -20°C ÷ +60°C /PE option = -20°C ÷ +60°C /BT option = -40°C ÷ +60°C
Storage temperature range	Standard = -20°C ÷ +70°C /PE option = -20°C ÷ +70°C /BT option = -40°C ÷ +70°C
Surface protection	Zinc coating with black passivation, galvanic treatment (axis card housing)
Corrosion resistance	Salt spray test (EN ISO 9227) > 200 h
Compliance	CE according to EMC directive 2014/30/EU (Immunity: EN 61000-6-2; Emission: EN 61000-6-3) RoHS Directive 2011/65/EU as last update by 2015/65/EU REACH Regulation (EC) n°1907/2006

10 HYDRAULIC CHARACTERISTICS - based on mineral oil ISO VG 46 at 50 °C

Valve model	DLHZO											DLKZOR							
	ports P, A, B = 350; T = 210 (250 with external drain /Y) Y = 10											ports P, A, B = 315; T = 210 (250 with external drain /Y) Y = 10							
Pressure limits [bar]	L0	L1	V1	L3	V3	L5	T5	L7	T7	V7	D7	DT7	L3	T3	L7	T7	V7	D7	DT7
Nominal flow Δp P-T [l/min] (1)																			
Δp= 30 bar	2,5	4,5	8	9	13	18		26			26÷13 (4)		40		60			60÷33 (4)	
Δp= 70 bar	4	7	12	14	20	28		40			40÷20 (4)		60		100			100÷50 (4)	
Max permissible flow	8	14	16	30	40	50		70			70÷40 (4)		90		160			160÷80 (4)	
Leakage (2) [cm³/min]	<100	<200	<100	<300	<150	<500	<200	<900	<200	<200	<700	<200	<1000	<400	<1500	<400	<400	<1200	<400
Response time (3) [ms]	≤ 10											≤ 15							
Hysteresis	≤ 0,1 [% of max regulation]																		
Repeatability	± 0,1 [% of max regulation]																		
Thermal drift	zero point displacement < 1% at ΔT = 40°C																		

(1) For different Δp, the max flow is in accordance to the diagrams in section 13.2

(2) Referred to spool in neutral position and 50°C oil temperature

(3) 0-100% step signal

(4) For spool type D7 and DT7 the flow value is referred to single path P-A (A-T) ÷ P-B (B-T) at Δp/2 per control edge

11 ELECTRICAL CHARACTERISTICS

Power supplies	Nominal : +24 VDC Rectified and filtered : $V_{RMS} = 20 \div 32 V_{MAX}$ (ripple max 10 % VPP)			
Max power consumption	50 W			
Max. solenoid current	DLHZO = 2,6 A DLKZOR = 3 A			
Coil resistance R at 20°C	DLHZO = 3 \div 3,3 Ω DLKZOR = 3,8 \div 4,1 Ω			
Analog input signals	Voltage: range ± 10 VDC (24 VMAX tollerant) Current: range ± 20 mA		Input impedance: $R_i > 50$ k Ω Input impedance: $R_i = 500$ Ω	
Monitor outputs	Output range: voltage ± 10 VDC @ max 5 mA current ± 20 mA @ max 500 Ω load resistance			
Enable input	Range: 0 \div 5 Vdc (OFF state), 9 \div 24 Vdc (ON state), 5 \div 9 Vdc (not accepted); Input impedance: $R_i > 10$ k Ω			
Fault output	Output range: 0 \div 24 Vdc (ON state > [power supply - 2 V] ; OFF state < 1 V) @ max 50 mA; external negative voltage not allowed (e.g. due to inductive loads)			
Position transducers power supply	+24 Vdc @ max 100 mA and +5 Vdc @ max 100 mA are software selectable; ± 10 Vdc @ max 14 mA minimum load resistance 700 Ω			
Pressure/Force transducer power supply (only for SF, SL)	+24Vdc @ max 100 mA (E-ATR-8 see tech table GS465)			
Alarms	Solenoid not connected/short circuit, cable break with current reference signal, over/under temperature, valve spool transducer malfunctions, alarms history storage function			
Insulation class	H (180°) Due to the occuring surface temperatures of the solenoid coils, the European standards ISO 13732-1 and EN982 must be taken into account			
Protection degree to DIN EN60529	IP66 / IP67 with mating connectors			
Duty factor	Continuous rating (ED=100%)			
Tropicalization	Tropical coating on electronics PCB			
Additional characteristics	Short circuit protection of solenoid's current supply; 3 leds for diagnostic; protection against reverse polarity of power supply			
Electromagnetic compatibility (EMC)	According to Directive 2014/30/UE (Immunity: EN 61000-6-2; Emission: EN 61000-6-3)			
Communication interface	USB	CANopen	PROFIBUS DP	EtherCAT, POWERLINK, EtherNet/IP, PROFINET IO RT / IRT EC 61158
	Atos ASCII coding	EN50325-4 + DS408	EN50170-2/IEC61158	
Communication physical layer	not insulated USB 2.0 + USB OTG	optical insulated CAN ISO11898	optical insulated RS485	Fast Ethernet, insulated 100 Base TX
Recommended wiring cable	LiYCY shielded cables, see section 22			

Note: a maximum time of 800 ms (depending on communication type) have be considered between the axis card energizing with the 24 Vdc power supply and when the valve is ready to operate. During this time the current to the valve coils is switched to zero.

12 SEALS AND HYDRAULIC FLUIDS - for other fluids not included in below table, consult our technical office

Seals, recommended fluid temperature	NBR seals (standard) = -20°C \div +60°C, with HFC hydraulic fluids = -20°C \div +50°C FKM seals (/PE option) = -20°C \div +80°C NBR low temp. seals (/BT option) = -40°C \div +60°C, with HFC hydraulic fluids = -40°C \div +50°C		
Recommended viscosity	20 \div 100 mm ² /s - max allowed range 15 \div 380 mm ² /s		
Max fluid contamination level	normal operation	ISO4406 class 18/16/13 NAS1638 class 7	see also filter section at www.atos.com or KTF catalog
	longer life	ISO4406 class 16/14/11 NAS1638 class 5	
Hydraulic fluid	Suitable seals type	Classification	Ref. Standard
Mineral oils	NBR, FKM, NBR low temp.	HL, HLP, HLPD, HVLP, HVLPD	DIN 51524
Flame resistant without water	FKM	HFDU, HFDR	ISO 12922
Flame resistant with water	NBR, NBR low temp.	HFC	

13 **DIAGRAMS** (based on mineral oil ISO VG 46 at 50 °C)

13.1 Regulation diagrams

- 1 = Linear spools L
- 2 = Differential - linear spool D7
- 3 = Differential non linear spool DT7
- 4 = Non linear spool T5 (only for DLHZO)
- 5 = Non linear spool T3 (only for DLHZO) and T7
- 6 = Progressive spool V

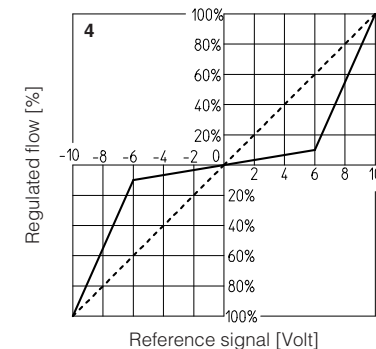
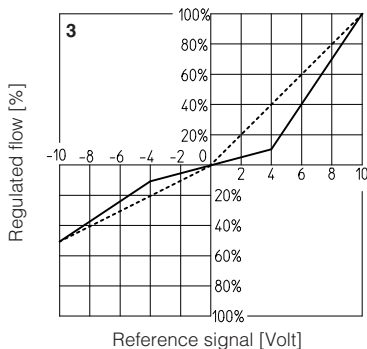
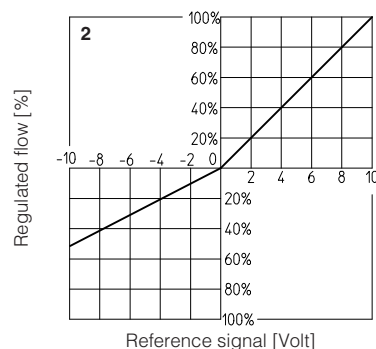
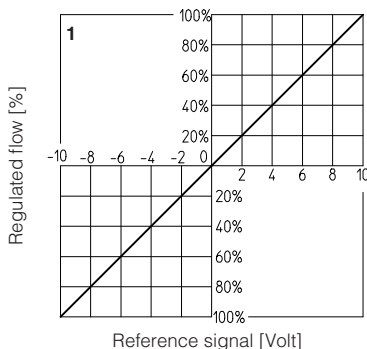

T3, T5 and T7 spool types are specific for fine low flow control in the range from 0 to 60% (T5) and 0 to 40% (T3 and T7) of max spool stroke.

The non linear characteristics of the spool is compensated by the axis card, so the final valve regulation is resulting linear respect the reference signal (dotted line).

DT7 has the same characteristic of T7 but it is specific for applications with cylinders with area ratio 1:2

Note:

Hydraulic configuration vs. reference signal:

Standard:

Reference signal $0 \div +10 \text{ V}$ } P → A / B → T
 $12 \div 20 \text{ mA}$

Reference signal $0 \div -10 \text{ V}$ } P → B / A → T
 $12 \div 4 \text{ mA}$

option /B:

Reference signal $0 \div +10 \text{ V}$ } P → B / A → T
 $12 \div 20 \text{ mA}$

Reference signal $0 \div -10 \text{ V}$ } P → A / B → T
 $12 \div 4 \text{ mA}$

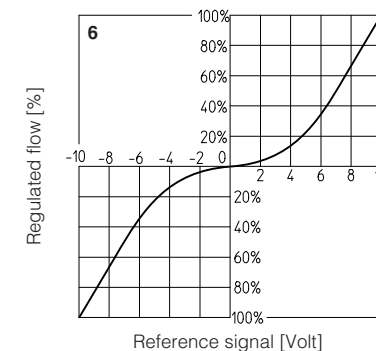
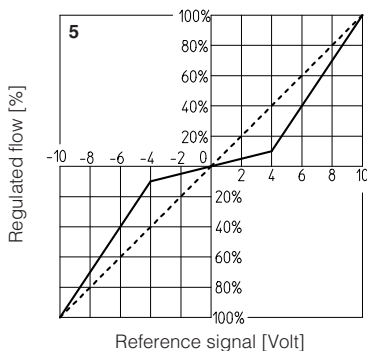

13.2 Flow /Δp diagrams

Stated at 100% of spool stroke

DLHZO:

- 1 = spool L7, T7, V7, D7, DT7
- 2 = spool L5, T5
- 3 = spool V3
- 4 = spool L3
- 5 = spool L1, V1
- 6 = spool L0

DLKZOR:

- 7 = spool L7, T7, V7, D7, DT7
- 8 = spool L3

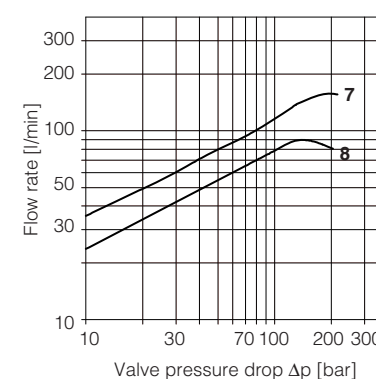
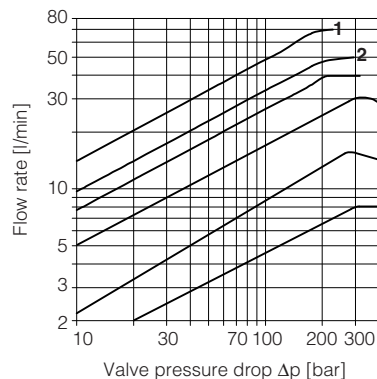

13.3 Pressure gain

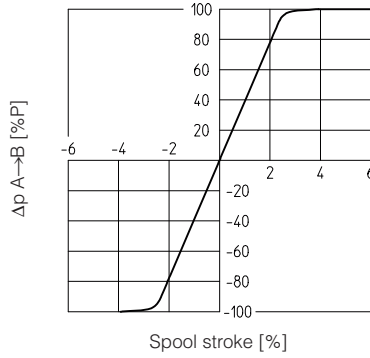
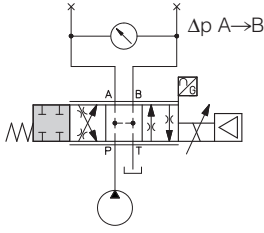

13.4 Response time

The response times in below diagrams are measured at different steps of the reference input signal. They have to be considered as average values.

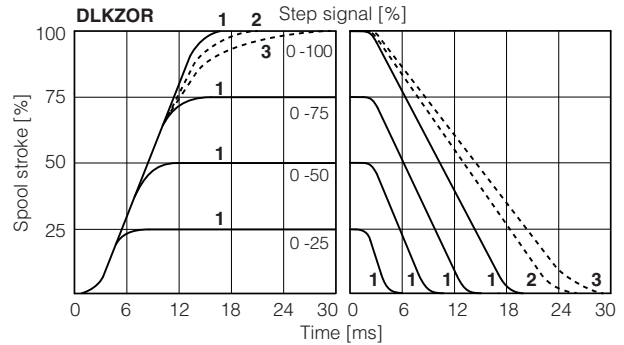
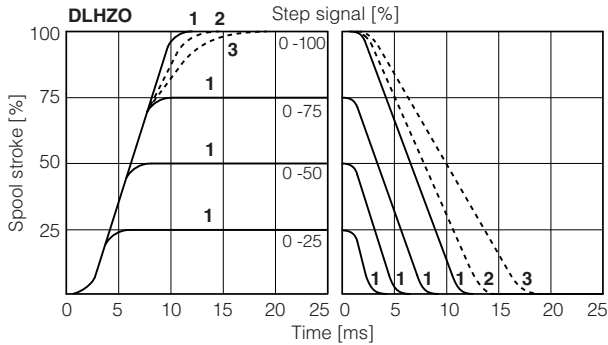

1 = dynamic 2 = balanced (*) 3 = smooth (*)

(*) Response time is represented only for 0-100% step; for intermediate steps, the response time increment of presets 2 (balanced) and 3 (smooth) with respect to the preset 1 (dynamic) is proportional to the step amplitude of the reference input signal

13.5 DLHZO Bode diagrams

Stated at nominal hydraulic conditions

± 5% nominal stroke:

- 1 = dynamic
- 2 = balanced
- 3 = smooth

± 100% nominal stroke:

- 4 = dynamic
- 5 = balanced
- 6 = smooth

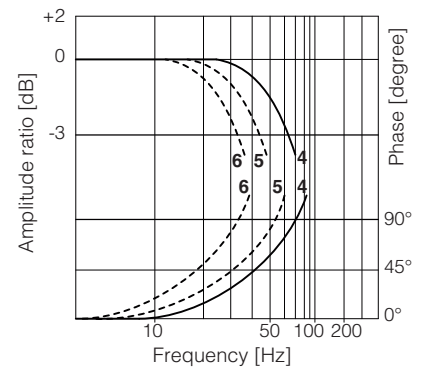
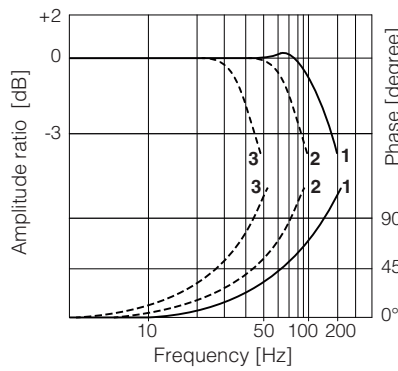

13.6 DLKZOR Bode diagrams

Stated at nominal hydraulic conditions

± 5% nominal stroke:

- 1 = dynamic
- 2 = balanced
- 3 = smooth

± 100% nominal stroke:

- 4 = dynamic
- 5 = balanced
- 6 = smooth

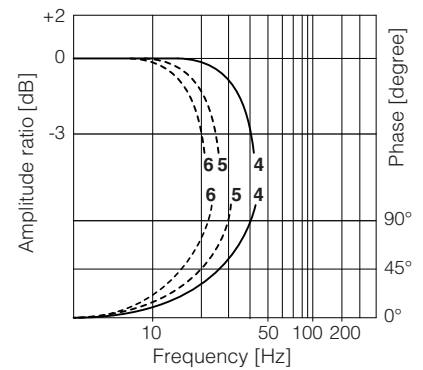
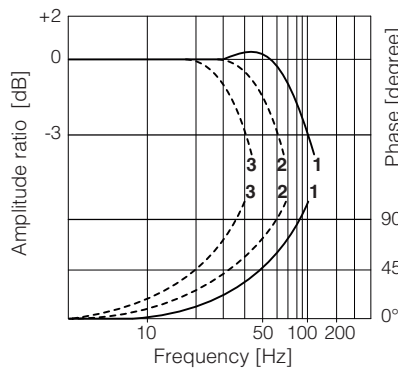

14 FAIL SAFE POSITION

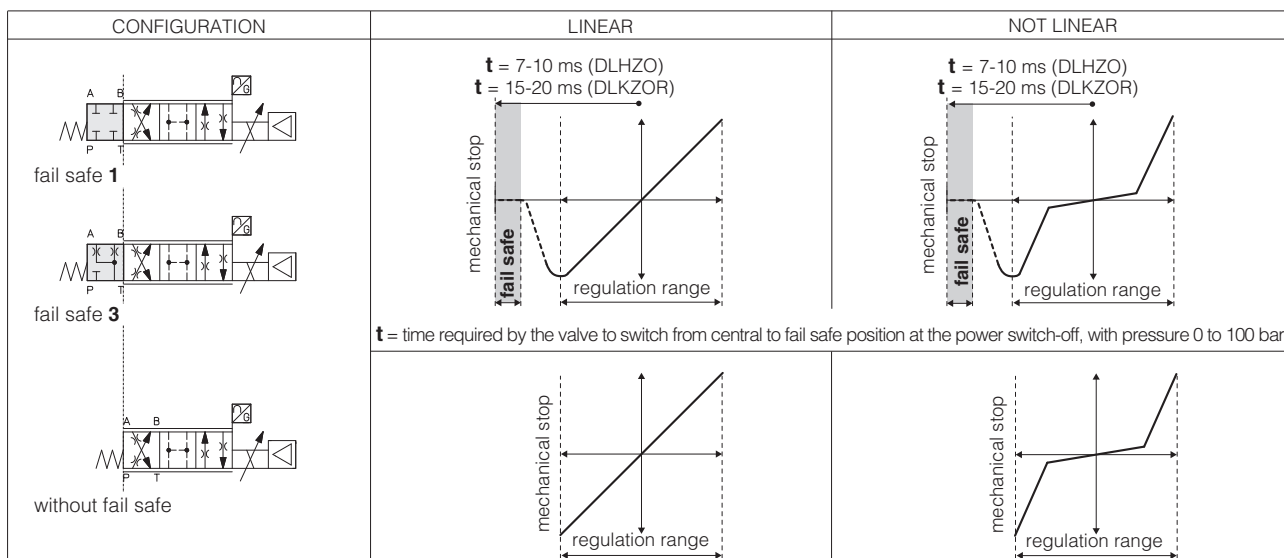

Fail safe connections		P → A	P → B	A → T	B → T
Leakage [cm ³ /min] at P = 100 bar (1)	Fail safe 1	50	70	70	50
	Fail safe 3	50	70	-	-
Flow [l/min] (2)	DLHZO	-	-	15÷30	10÷20
	DLKZOR	-	-	40÷60	25÷40

(1) Referred to spool in fail safe position and 50°C oil temperature

(2) Referred to spool in fail safe position at $\Delta p = 35$ bar per edge

15 HYDRAULIC OPTIONS

B = Solenoid, on-board digital driver + axis card and LVDT position transducer at side of port A.

For hydraulic configuration vs reference signal, see 13.1

Y = This option is mandatory if the pressure in port T exceeds 210 bar.

16 ELECTRONICS OPTIONS

I = This option provides 4 ± 20 mA current reference and monitor signals, instead of the standard ± 10 VDC.

Input signal can be reconfigured via software selecting between voltage and current, within a maximum range of ± 10 Vdc or ± 20 mA.

It is normally used in case of long distance between the machine control unit and the valve or where the reference signal can be affected by electrical noise; the valve functioning is disabled in case of reference signal cable breakage.

C = This option is available to connect analog position transducer and pressure/force transducers with 4 ± 20 mA current output signal, instead of the standard ± 10 VDC.

Input signal can be reconfigured via software selecting between voltage and current, within a maximum range of ± 10 Vdc or ± 20 mA.

17 POSSIBLE COMBINED OPTIONS

Standard versions for D-SN:

/BI, /BIY, /BY, /IY

Safety certified versions for D-SN:

/BIU, /BIUY, /BU, /BUY, /IU, /IUY, /UY
/BIK, /BIKY, /BK, /BKY, /IK, /IKY, /KY

Standard versions for A-SN, A-SF, A-SL and D-SF, D-SL:

/BC, /BCI, /BCIY, /BCY, /BI, /BIY, /BY,
/CI, /CIY, /CY,
/IY

Safety certified versions for A-SN, A-SF, A-SL and D-SF, D-SL:

/BCU, /BCIU, /BCIUY, /BCUY, /BIU, /BIUY, /BU, /BUY,
/CU, /CIU, /CIUY, /CUY, /IU, /IUY, /UY
/BCK, /BCKI, /BCKIY, /BCKY, /BIK, /BIKY, /BK, /BKY,
/CK, /CIK, /CIKY, /CKY, /IK, /IKY, /KY

18 POWER SUPPLY AND SIGNALS SPECIFICATIONS

Generic electrical output signals of the valve (e.g. fault or monitor signals) must not be directly used to activate safety functions, like to switch-ON/OFF the machine's safety components, as prescribed by the European standards (Safety requirements of fluid technology systems and components-hydraulics, ISO 4413).

For certified safety options: **/U** see tech. table **FY100** and **/K** see tech. table **FY200**

18.1 Power supply (V+ and V0)

The power supply must be appropriately stabilized or rectified and filtered: apply at least a 10000 μ F/40 V capacitance to single phase rectifiers or a 4700 μ F/40 V capacitance to three phase rectifiers. In case of separate power supply see 18.2.

 A safety fuse is required in series to each power supply: 2,5 A time lag fuse.

18.2 Power supply for axis card logic and communication (VL+ and VL0)

The power supply for axis card logic and communication must be appropriately stabilized or rectified and filtered: apply at least a 10000 μ F/40 V capacitance to single phase rectifiers or a 4700 μ F/40 V capacitance to three phase rectifiers.

The separate power supply for axis card logic on pin 9 and 10, allow to remove solenoid power supply from pin 1 and 2 maintaining active the diagnostics, USB and fieldbus communications.

 A safety fuse is required in series to each axis card logic and communication power supply: 500 mA fast fuse.

18.3 Position reference input signal (P_INPUT+)

Functionality of P_INPUT+ signal (pin 4), depends on axis card reference mode, see section [2](#) :

external analog reference (see 2.1): input is used as reference for control in closed loop the actuator position.

Reference input signal is factory preset according to selected valve code, defaults are ± 10 VDC for standard and $4 \div 20$ mA for /I option. Input signal can be reconfigured via software selecting between voltage and current, within a maximum range of ± 10 VDC or ± 20 mA.

external fieldbus reference (see 2.1) or *automatic cycle* (see 2.2): analog reference input signal can be used as on-off commands with input range $0 \div 24$ VDC.

18.4 Force reference input signal (F_INPUT+) - only for SF, SL

Functionality of F_INPUT+ signal (pin 7), depends on selected axis card reference mode and alternated control options, see section [3](#) :

SL, SF controls and external analog reference selected : input is used as reference for the axis card force closed loop.

Reference input signal is factory preset according to selected valve code, defaults are ± 10 VDC for standard and $4 \div 20$ mA for /I option. Input signal can be reconfigured via software selecting between voltage and current, within a maximum range of ± 10 VDC or ± 20 mA.

SN control or fieldbus reference selected: analog reference input signal can be used as on-off commands with input range $0 \div 24$ VDC.

18.5 Position monitor output signal (P_MONITOR)

The axis card generates an analog output signal proportional to the actual axis position; the monitor output signal can be software set to show other signals available in the axis card (e.g. analog reference, fieldbus reference, position error, valve spool position).

Monitor output signal is factory preset according to selected valve code, defaults are ± 10 VDC for standard and $4 \div 20$ mA for /I option.

Output signal can be reconfigured via software selecting between voltage and current, within a maximum range of ± 10 VDC or ± 20 mA.

18.6 Force monitor output signal (F_MONITOR) - only for SF, SL

The axis card generates an analog output signal according to alternated force control option:

SN control: output signal is proportional to the actual valve spool position

SL, SF controls: output signal is proportional to the actual force applied to the cylinder's rod end

Monitor output signals can be software set to show other signals available in the axis card (e.g. analog reference, force reference).

The output range and polarity are software selectable within the maximum range ± 10 VDC or ± 20 mA.

Monitor output signal is factory preset according to selected valve code, defaults are ± 10 VDC for standard and $4 \div 20$ mA for /I option.

Output signal can be reconfigured via software selecting between voltage and current, within a maximum range of ± 10 VDC or ± 20 mA.

18.7 Enable input signal (ENABLE)

To enable the axis card, a 24VDC voltage has to be applied on pin 3.

When the Enable signal is set to zero the axis card can be software set to perform one of the following actions:

- maintain the actuator actual position in close loop control
- move towards a predefined position in closed loop control and maintains the reached position (hold position)
- move forward or backward in open loop (only the valve's closed loop remain active)

18.8 Fault output signal (FAULT)

Fault output signal indicates fault conditions of the axis card (solenoid short circuits/not connected, reference or transducer signal cable broken, maximum error exceeded, etc.). Fault presence corresponds to 0 Vdc, normal working corresponds to 24 VDC.

Fault status is not affected by the Enable input signal.

Fault output signal can be used as digital output by software selection.

18.9 Position transducer input signal

A position transducer must be always directly connected to the axis card. Select the correct axis card execution depending on the desired transducer interface: digital SSI or Encoder (D execution), potentiometer or a generic transducer with analog interface (A execution).

Position digital input signal is factory preset to binary SSI, it can be reconfigured via software selecting between binary/gray SSI and Encoder.

Position analog input signal is factory preset according to selected valve code, defaults are ± 10 VDC for standard and $4 \div 20$ mA for /C option.

Input signal can be reconfigured via software selecting between voltage and current, within a maximum range of ± 10 VDC or ± 20 mA.

Refer to position transducer characteristics to select the transducer type according to specific application requirements (see 19.1).

18.10 Remote pressure/force transducer input signals - only for SF, SL

Analog remote pressure transducers or load cell can be directly connected to the axis card.

Analog input signal is factory preset according to selected valve code, defaults are ± 10 Vdc for standard and $4 \div 20$ mA for /C option.

Input signal can be reconfigured via software selecting between voltage and current, within a maximum range of ± 10 Vdc or ± 20 mA.

Refer to pressure/force transducer characteristics to select the transducer type according to specific application requirements (see 19.2).

19 ACTUATOR'S TRANSDUCER CHARACTERISTICS

19.1 Position transducers

The accuracy of the position control is strongly dependent to the selected position transducer. Four different transducer interfaces are available on the axis cards, depending to the system requirements: potentiometer or analog signal (A execution), SSI or Encoder (D execution). Transducers with digital interface allow high resolution and accurate measures, that combined with fieldbus communication grants highest performances. Transducers with analog interface grant simple and cost effective solutions.

19.2 Pressure/force transducers

The accuracy of the force control is strongly dependent to the selected pressure/force transducer, see section 3. Alternated force controls require to install pressure transducers or load cell to measure the actual pressure/force values. Pressure transducers allow easy system integration and cost effective solution for alternated position/force controls (see tech table **GS465** for pressure transducers details). Load cell transducers allow the user to get high accuracy and precise regulations for alternated position/force control. The characteristics of the remote pressure/force transducers must be always selected to match the application requirements and to obtain the best performances: transducer nominal range should be at least 115%÷120% of the maximum regulated pressure/force.

19.3 Transducers characteristics & interfaces - following values are just for reference, for details please consult the transducer's datasheet

Execution	Position				Pressure/Force
	A		D		SF, SL
Input type	Potentiometer	Analog	SSI (3)	Incremental Encoder	Analog
Power supply (1)	±10 Vdc	+24 Vdc	+5 Vdc / +24 Vdc	+5 Vdc / +24 Vdc	+24 Vdc
Axis card interface	±10V	0 ÷ 10V 4 ÷ 20 mA	Serial SSI binary/gray	TTL 5Vpp - 150 KHz	±10 Vdc 4 ÷ 20 mA
Max speed	0,5 m/s	1 m/s	2 m/s	2 m/s	-
Max resolution	< 0.4 % FS	< 0.2 % FS	1 µm	1 µm (@ 0.15 m/s)	< 0.4 % FS
Linearity error (2)	± 0.1% FS	< ±0.03% FS	< ± 0.01 % FS	< ± 0.001 % FS	< ±0.25% FS
Repeatability (2)	± 0.05% FS	< ± 0.005% FS	< ± 0.001 % FS	< ± 0.001 % FS	< ±0.1% FS

(1) Power supply provided by Atos axis card (2) Percentage of total stroke (3) For Balluff BTL7 with SSI interface only special code SA433 is supported

20 ELECTRONIC CONNECTIONS

For electronic connection of certified safety options /U see tech. table **FY100** and /K see tech. table **FY200**

20.1 Main connector - 12 pin (A)

PIN	SIGNAL	TECHNICAL SPECIFICATIONS	NOTES
1	V+	Power supply 24 Vdc	Input - power supply
2	V0	Power supply 0 Vdc	Gnd - power supply
3	ENABLE	Enable (24 Vdc) or disable (0 Vdc) the axis card, referred to VL0	Input - on/off signal
4	P_INPUT+	Position reference input signal: ±10 Vdc / ±20 mA maximum range	Input - analog signal Software selectable
5	INPUT-	Negative reference input signal for P_INPUT+ and F_INPUT+	Gnd - analog signal
6	P_MONITOR	Position monitor output signal: ±10 Vdc / ±20 mA maximum range, referred to VL0	Output - analog signal Software selectable
7	F_INPUT+	Force reference input signal (SF, SL controls): ±10 Vdc / ±20 mA maximum range	Input - analog signal Software selectable
8	F_MONITOR	Force (SF, SL controls) or valve spool position (SN control) monitor output signal: ±10 Vdc / ±20mA maximum range, referred to VL0	Output - analog signal Software selectable
9	VL+	Power supply 24 Vdc for axis card logic and communication	Input - power supply
10	VL0 (1)	Power supply 0 Vdc for axis card logic and communication	Gnd - power supply
11	FAULT	Fault (0 Vdc) or normal working (24 Vdc), referred to VL0	Output - on/off signal
PE	EARTH	Internally connected to axis card housing	

(1) Do not disconnect VL0 before VL+ when the axis card is connected to PC USB port

20.2 Communication connectors (B) - (C)

(B) USB connector - M12 - 5 pin always present		
PIN	SIGNAL	TECHNICAL SPECIFICATION (1)
1	+5V_USB	Power supply
2	ID	Identification
3	GND_USB	Signal zero data line
4	D-	Data line -
5	D+	Data line +

(C1) (C2) BC fieldbus execution, connector - M12 - 5 pin		
PIN	SIGNAL	TECHNICAL SPECIFICATION (1)
1	CAN_SHLD	Shield
2	not used	(C1) - (C2) pass-through connection (2)
3	CAN_GND	Signal zero data line
4	CAN_H	Bus line (high)
5	CAN_L	Bus line (low)

(C1) (C2) BP fieldbus execution, connector - M12 - 5 pin		
PIN	SIGNAL	TECHNICAL SPECIFICATION (1)
1	+5V	Termination supply signal
2	LINE-A	Bus line (high)
3	DGND	Data line and termination signal zero
4	LINE-B	Bus line (low)
5	SHIELD	

(C1) (C2) EH, EW, EI, EP fieldbus execution, connector - M12 - 4 pin		
PIN	SIGNAL	TECHNICAL SPECIFICATION (1)
1	TX+	Transmitter
2	RX+	Receiver
3	TX-	Transmitter
4	RX-	Receiver
Housing	SHIELD	

(1) Shield connection on connector's housing is recommended

(2) Pin 2 can be fed with external +5V supply of CAN interface

20.3 Remote pressure/force transducer connector - M12 - 5 pin - only for SF, SL (D)

PIN	SIGNAL	TECHNICAL SPECIFICATION	NOTES	(D1) SL - Single transducer (1)		(D2) SF - Double transducers (1)	
				Voltage	Current	Voltage	Current
1	VF +24V	Power supply +24Vdc	Output - power supply	Connect	Connect	Connect	Connect
2	TR1	1st signal transducer: ±10 Vdc / ±20 mA maximum range	Input - analog signal Software selectable	Connect	Connect	Connect	Connect
3	AGND	Common gnd for transducer power and signals	Common gnd	Connect	/	Connect	/
4	TR2	2nd signal transducer: ±10 Vdc / ±20 mA maximum range	Input - analog signal Software selectable	/	/	Connect	Connect
5	NC	Not connect		/	/	/	/

(1) Single/double transducer configuration is software selectable

Remote pressure transducers connection - example

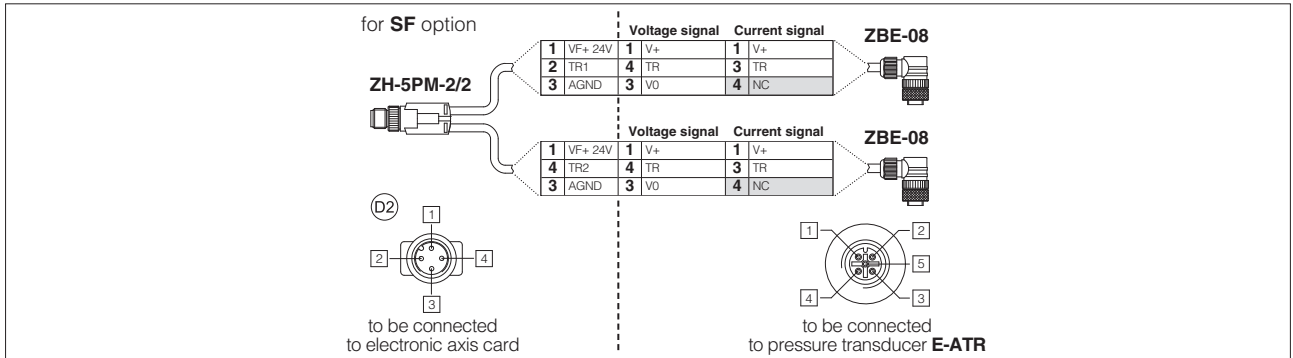

Note: pin layout always referred to axis card view

20.4 D execution - Digital position transducers connector - M12 - 8 pin (E1)

SSI - default transducer (1)				Encoder (1)		
PIN	SIGNAL	TECHNICAL SPECIFICATION	NOTES	SIGNAL	TECHNICAL SPECIFICATION	NOTES
1	CLOCK+	Serial synchronous clock (+)	Input - digital signal	R	Input channel R	Input - digital signal
2	CLOCK-	Serial synchronous clock (-)		/R	Input channel /R	
3	DATA+	Serial position data (+)		A	Input channel A	
4	DATA-	Serial position data (-)		/A	Input channel /A	
5	NC	Not connect	Do not connect	B	Input channel B	
6	NC		Do not connect	/B	Input channel /B	
7	VP	Power supply: +24Vdc, +5Vdc or OFF (default OFF)	Output - power supply Software selectable	VP	Power supply: +24Vdc, +5Vdc or OFF (default OFF)	Output - power supply Software selectable
8	0V	Common gnd for transducer power and signals	Common gnd	0V	Common gnd for transducer power and signals	Common gnd

(1) Digital position transducer type is software selectable: Encoder or SSI, see 18.9

SSI connection - example

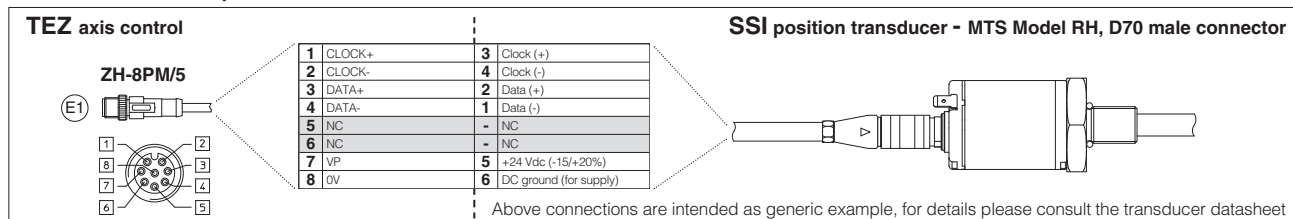

Note: pin layout referred to axis card view

Encoder connection - example

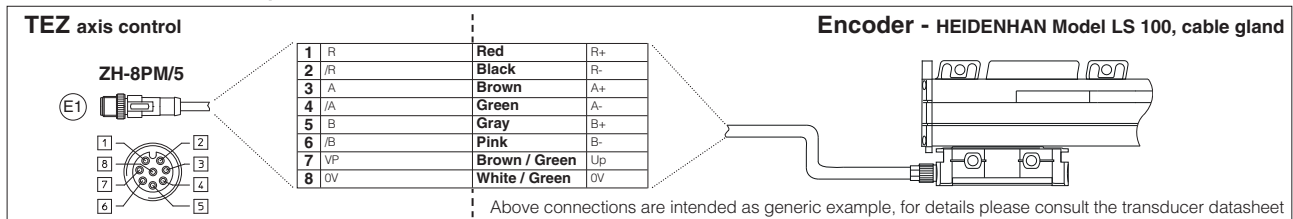

Note: pin layout referred to axis card view

20.5 A execution - Analog position transducers connector - M12 - 5 pin (E2)

PIN	SIGNAL	TECHNICAL SPECIFICATION	NOTES	Potentiometer	Analog
1	VP +24V	Power supply: +24Vdc or OFF (default OFF)	Output - power supply Software selectable	/	Connect
2	VP +10V	Power supply reference +10Vdc (always present)	Output - power supply	Connect	/
3	AGND	Common gnd for transducer power and signals	Common gnd	Connect	Connect
4	TR	Signal transducer	Input - analog signal	Connect	Connect
5	VP -10V	Power supply reference -10Vdc (always present)	Output - power supply	Connect	/

Note: analog input range is software selectable, see 18.9

20.6 TEZ connections layout

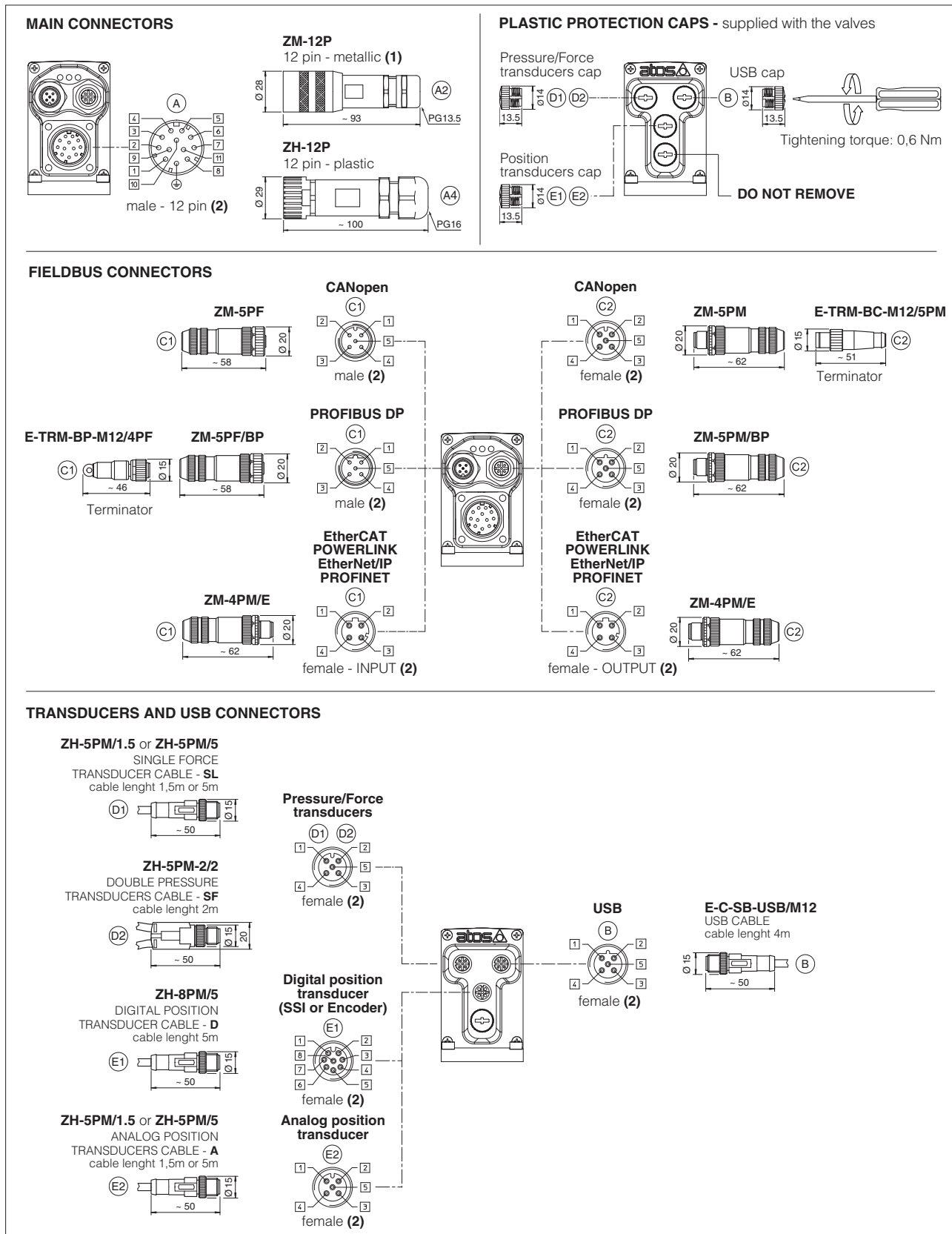

(1) Use of metallic connectors is strongly recommended in order to fulfill EMC requirements (2) Pin layout always referred to axis card view

20.7 Diagnostic LEDs (L)

Three leds show axis card operative conditions for immediate basic diagnostics. Please refer to the axis card user manual for detailed information.

FIELDBUS	NP Not Present	BC CANopen	BP PROFIBUS DP	EH EtherCAT	EW POWERLINK	EI EtherNet/IP	EP PROFINET	L1 L2 L3
L1		VALVE STATUS			LINK/ACT			
L2		NETWORK STATUS			NETWORK STATUS			
L3		SOLENOID STATUS			LINK/ACT			

21 IN / OUT FIELDBUS COMMUNICATION CONNECTORS

Two fieldbus communication connectors are always available for digital axis card executions BC, BP, EH, EW, EI, EP. This feature allows considerable technical advantages in terms of installation simplicity, wiring reduction and also avoids the use of expensive T-connectors.

For BC and BP executions the fieldbus connectors have an internal pass-through connection and can be used like an end point of the fieldbus network, using an external terminator (see tech table **GS500**).

For EH, EW, EI and EP execution the external terminators are not required: each connector is internally terminated.

BC and BP pass-through connection

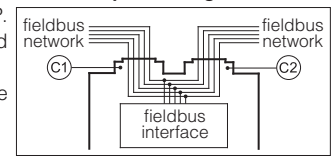

22 CONNECTORS CHARACTERISTICS - to be ordered separately

22.1 Main connectors

CONNECTOR TYPE	POWER SUPPLY	POWER SUPPLY
CODE	(A1) ZM-12P	(A2) ZH-12P
Type	12pin female straight circular	12pin female straight circular
Standard	DIN 43651	DIN 43651
Material	Metallic	Plastic reinforced with fiber glass
Cable gland	PG13,5	PG16
Recommended cable	LiYCY 12 x 0,75 mm ² max 20 m (logic and power supply)	LiYCY 10 x 0,14mm ² max 40 m (logic) LiYY 3 x 1mm ² max 40 m (power supply)
Conductor size	0,5 mm ² to 1,5 mm ² - available for 12 wires	0,14 mm ² to 0,5 mm ² - available for 9 wires 0,5 mm ² to 1,5 mm ² - available for 3 wires
Connection type	to crimp	to crimp
Protection (EN 60529)	IP 67	IP 67

22.2 Fieldbus communication connectors

CONNECTOR TYPE	BC CANopen (1)		BP PROFIBUS DP (1)		EH EtherCAT, EW POWERLINK, EI EtherNet/IP, EP PROFINET (2)	
CODE	(C1) ZM-5PF	(C2) ZM-5PM	(C1) ZM-5PF/BP	(C2) ZM-5PM/BP	(C1) (C2) ZM-4PM/E	
Type	5 pin female straight circular	5 pin male straight circular	5 pin female straight circular	5 pin male straight circular	4 pin male straight circular	
Standard	M12 coding A – IEC 61076-2-101		M12 coding B – IEC 61076-2-101		M12 coding D – IEC 61076-2-101	
Material	Metallic		Metallic		Metallic	
Cable gland	Pressure nut - cable diameter 6÷8 mm		Pressure nut - cable diameter 6÷8 mm		Pressure nut - cable diameter 4÷8 mm	
Cable	CANbus Standard (DR 303-1)		PROFIBUS DP Standard		Ethernet standard CAT-5	
Connection type	screw terminal		screw terminal		terminal block	
Protection (EN 60529)	IP67		IP 67		IP 67	

(1) E-TRM-** terminators can be ordered separately, see tech table **GS500**

(2) Internally terminated

22.3 Pressure/Force transducer connectors - only for SF, SL

CONNECTOR TYPE	SL - Single transducer		SF - Double transducers
CODE	(D1) ZH-5PM/1.5	(D1) ZH-5PM/5	(D2) ZH-5PM-2/2
Type	5 pin male straight circular		4 pin male straight circular
Standard	M12 coding A – IEC 61076-2-101		M12 coding A – IEC 61076-2-101
Material	Plastic		Plastic
Cable gland	Connector moulded on cables 1,5 m length 5 m length		Connector moulded on cables 2 m length
Cable	5 x 0,25 mm ²		3 x 0,25 mm ² (both cables)
Connection type	molded cable		splitting cable
Protection (EN 60529)	IP 67		IP 67

22.4 Position transducer connectors

CONNECTOR TYPE	DIGITAL POSITION TRANSDUCER D execution - see 19.4	ANALOG POSITION TRANSDUCER A execution - see 19.5
CODE	(E1) ZH-8PM/5	(E2) ZH-5PM/1.5 (E2) ZH-5PM/5
Type	8 pin male straight circular	5 pin male straight circular
Standard	M12 coding A – IEC 61076-2-101	M12 coding A – IEC 61076-2-101
Material	Plastic	Plastic
Cable gland	Connector moulded on cables 5 m length	Connector moulded on cables 1,5 m length 5 m length
Cable	8 x 0,25 mm ²	5 x 0,25 mm ²
Connection type	molded cable	molded cable
Protection (EN 60529)	IP 67	IP 67

23 MAIN SOFTWARE PARAMETER SETTINGS

For a detailed descriptions of the available settings, wirings and installation procedures, please refer to the user manuals included in the Z-SW programming software:

- Z-MAN-RI-LEZ** - user manual for **TEZ** and **LEZ** with **SN**
- Z-MAN-RI-LEZ-S** - user manual for **TEZ** and **LEZ** with **SF, SL**

23.1 External reference and transducer parameters

- Allow to configure the axis card reference and transducer inputs, analog or digital, to match the specific application requirements:
- *Scaling parameters* define the correspondence of these signals with the specific actuator stroke or force to be controlled
 - *Limit parameters* define maximum/minimum stroke and force to detect possible alarm conditions
 - *Homing parameters* define the startup procedure to initialize incremental transducer (e.g. Encoder)

23.2 PID control dynamics parameters

- Allow to optimize and adapt the axis card closed loop to the wide range of hydraulic system characteristics:
- *PID parameters* each part of the closed loop algorithm (proportional, integral, derivative, feed forward, fine positioning, etc) can be modified to match the application requirements

23.3 Monitoring parameters

- Allow to configure the axis card monitoring function of the positioning error (difference between actual reference and feedback) and detects anomalous conditions:
- *Monitoring parameters* maximum allowed errors can be set for both static and dynamic positioning phases, and dedicated waiting times can be set to delay the activation of the alarm condition and relevant reaction (see 23.4)

23.4 Fault parameters

- Allow to configure how the axis card detect and react to alarm conditions:
- *Diagnostics parameters* define different conditions, threshold and delay time to detect alarm conditions
 - *Reaction parameters* define different actions to be performed in case of alarm presence (stop at actual or preprogrammed position, emergency forward/backward, axis card disabling, etc.)



23.5 Valve characteristics compensation

- Allow to modify the valve regulation to match the actuator/system characteristics and to obtain the best overall performances:
- *Valve parameters* modify the standard valve regulation by means of deadband compensation, curve linearization and differentiated gain for positive and negative regulation

23.6 Motion phases parameters

When the internal reference generation is active a pre-programmed cycle can be generated; start/stop/switch-over commands and reference generation types parameters can be set to design a customized sequence of motion phases adapted to the specific application requirements (see 2.2).

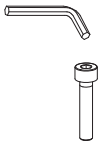
24 FASTENING BOLTS AND SEALS

	<p>DLHZO</p>	<p>DLKZOR</p>
	<p>Fastening bolts: 4 socket head screws M5x50 class 12.9 Tightening torque = 8 Nm</p>	<p>Fastening bolts: 4 socket head screws M6x40 class 12.9 Tightening torque = 15 Nm</p>
	<p>Seals: 4 OR 108; Diameter of ports A, B, P, T: Ø 7,5 mm (max) 1 OR 2025 Diameter of port Y: Ø = 3,2 mm (only for /Y option)</p>	<p>Seals: 5 OR 2050; Diameter of ports A, B, P, T: Ø 11,2 mm (max) 1 OR 108 Diameter of port Y: Ø = 5 mm (only for /Y option)</p>

DLHZO-TEZ

ISO 4401: 2005
 Mounting surface: 4401-03-02-0-05 (see table P005)
 (for /Y surface 4401-03-03-0-05 without X port)

Mass [kg]	
DLHZO	2,3

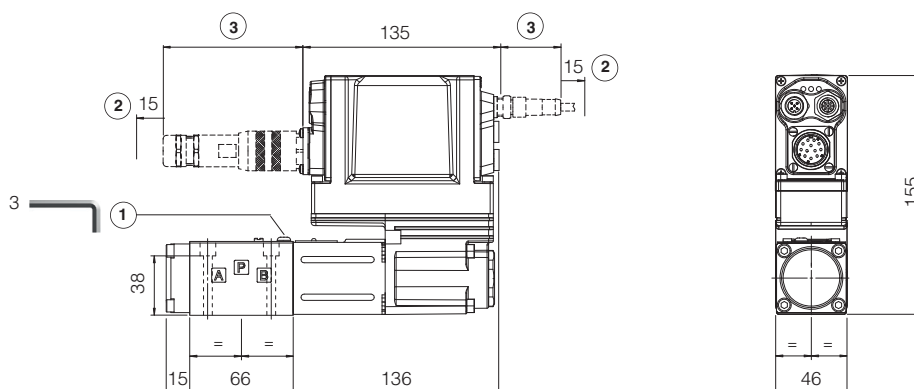

DLKZOR-TEZ

ISO 4401: 2005
 Mounting surface: 4401-05-04-0-05 (see table P005)
 (for /Y surface 4401-05-05-0-05 without X port)

Mass [kg]	
DLKZOR	4,3

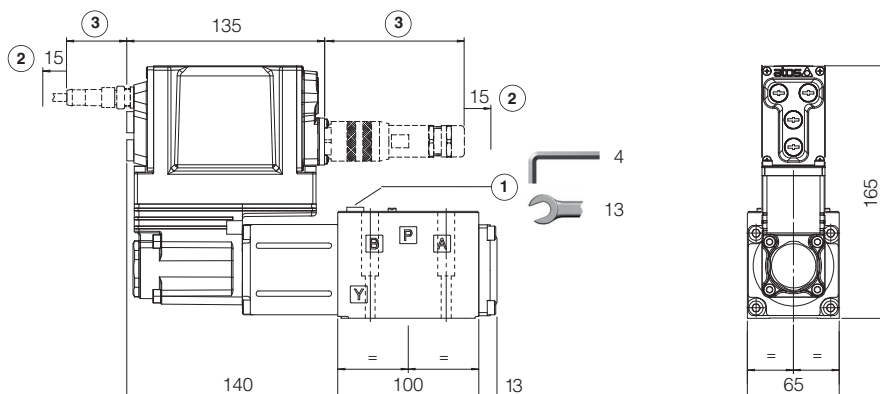

- ① = Air bleeding
- ② = Space to remove the connectors
- ③ = The dimensions of all connectors must be considered, see section 20.6

Note: for option /B the proportional solenoid, the LVDT transducer and the on-board digital driver + axis card are at side of port A

26 RELATED DOCUMENTATION

FS001	Basics for digital electrohydraulics	K800	Electric and electronic connectors
FS900	Operating and maintenance information for proportional valves	P005	Mounting surfaces for electrohydraulic valves
FY100	Safety proportional valves - option /U	Y010	Basics for safety components
FY200	Safety proportional valves - option /K	Z-MAN-RI-LEZ	TEZ/LEZ user manual
GS500	Programming tools	Z-MAN-RI-LEZ-S	TEZ/LEZ with P/Q control user manual
GS510	Fieldbus		