

# MARINE PRESSURE TRANSMITTER

Swiss based Trafag is a leading international supplier of high quality sensors and monitoring instruments for measurement of pressure and temperature. The industrial pressure transmitter EPN 8288, like its reliable predecessor the EPN 8298, has an exceptional ruggedness and a strong thin-film-on-steel sensor cell. The triple overpressure safety, a wide temperature range of up to 125°C and the marine certifications make the EPN 8288 the ideal solution for a wide variety of challenging applications.



## Applications

- Shipbuilding
- Engine manufacturing
- Machine tools
- Hydraulics



## Features

- Excellent long-term stability
- High resistance to over pressure
- Completely welded steel sensor system without additional seals
- Different accuracy classes

01/2024

Data sheet H72318k

## Technical Data

Measuring principle	Thin-film-on-steel	Accuracy @ 25°C typ.	± 0.5 % FS typ. ± 0.3 % FS typ.
Measuring range	0 ... 2.5 to 0 ... 600 bar 0 ... 30 to 0 ... 7500 psi	Media temperature	-40°C ... +125°C
Output signal	4 ... 20 mA, 0 ... 10 VDC	Ambient temperature	-40°C ... +125°C
NLH @ 25°C (BSL) typ.	± 0.2 % FS typ. ± 0.1 % FS typ.	Approval / conformity	DNV-GL EU RO Mutual Recognition Type Approval Certificate

Subject to change

## Ordering information/type code

							8288 . XX	XX	XX	XX	XX	XX
<b>Measuring range <sup>1)</sup></b>	<b>Pressure measurement range [bar]</b>	<b>Over pressure [bar]</b>	<b>Burst pressure [bar]</b>		<b>Pressure measurement range [psi]</b>	<b>Over pressure [psi]</b>	<b>Burst pressure [psi]</b>					
	0 ... 2.5	7.5	50	<b>75</b>	0 ... 30	90	700	<b>G5</b>				
	0 ... 4	12	60	<b>76</b>	0 ... 50	150	850	<b>G6</b>				
	0 ... 6	18	100	<b>77</b>	0 ... 100	300	1450	<b>G7</b>				
	0 ... 10	30	200	<b>78</b>	0 ... 150	450	2500	<b>G8</b>				
	0 ... 16	48	200	<b>79</b>	0 ... 200	600	2500	<b>GA</b>				
	0 ... 25	75	300	<b>80</b>	0 ... 250	750	2500	<b>G9</b>				
	0 ... 40	120	300	<b>81</b>	0 ... 300	900	4000	<b>HA</b>				
	0 ... 60	180	400	<b>82</b>	0 ... 400	1200	4000	<b>H0</b>				
	0 ... 100	300	500	<b>83</b>	0 ... 500	1500	4000	<b>H1</b>				
	0 ... 160	480	750	<b>85</b>	0 ... 1000	3000	5000	<b>H2</b>				
	0 ... 250	750	1000	<b>74</b>	0 ... 1500	4500	7000	<b>H3</b>				
	0 ... 400	1000	2000	<b>84</b>	0 ... 2000	6000	10000	<b>H5</b>				
	0 ... 600	1500	2500	<b>86</b>	0 ... 3000	9000	14500	<b>G4</b>				
					0 ... 5000	12500	21750	<b>H4</b>				
					0 ... 7500	18750	29000	<b>H6</b>				
	<b>Sensor</b>	Relative pressure, accuracy: 0.3 %; Material pressure connection and housing: 1.4542 (AISI630)							<b>23</b>			
Relative pressure, accuracy: 0.5 %; Material pressure connection and housing: 1.4542 (AISI630)							<b>25</b>					
Relative pressure, accuracy class: 0.3 %; Material pressure connection and housing: 1.4404 (AISI316L) <sup>2)</sup>							<b>33</b>					
Relative pressure, accuracy class: 0.5 %; Material pressure connection and housing: 1.4404 (AISI316L) <sup>2)</sup>							<b>35</b>					
<b>Pressure connection</b>	G1/4" male (Seal)								<b>17</b>			
	G1/2" male (Manometer) EN 837 <sup>3) 4)</sup>								<b>11</b>			
	1/4" NPT male <sup>3)</sup>								<b>30</b>			
	1/2" NPT male <sup>3)</sup>								<b>51</b>			
	R1/4" male, DIN3858 <sup>3)</sup>								<b>19</b>			
	M14x1.5 male, DIN6149-2 <sup>3)</sup>								<b>31</b>			
	9/16"-18UNF-2A male, SAE J1926-3 (Light Duty) <sup>3) 7)</sup>								<b>61</b>			
<b>Electrical connection</b>	Male electrical connector EN 175301-803-A (DIN 43650-A), Mat. PA									<b>05</b>		
<b>Output signal</b>	<b>Signal output</b>	<b>Load resistance</b>	<b>I (supply)</b>		<b>U (supply)</b>							
	4 ... 20 mA	(U <sub>supply</sub> -9 V) / 20 mA	< 10 mA		9 ... 32 VDC					<b>19</b>		
	0 ... 10 VDC	> 5 kΩ	< 10 mA		15 ... 32 VDC					<b>17</b>		
<b>Accessories</b>	Seal FPM, -18°C ... +125°C											<b>61</b>
	Seal EPDM, -40°C ... +125°C											<b>63</b>
	Seal NBR, -25°C ... +100°C											<b>83</b>
	Pressure peak damping element ø 1.0 mm, material 1.4305 <sup>4)</sup>											<b>40</b>
	Pressure peak damping element ø 0.4 mm, material 1.4305 (sensors 23, 25) resp. 1.4404 (sensors 33, 35) <sup>4)</sup>											<b>44</b>
	Female electrical plug EN 175301-803-A (DIN43650-A)/NBR, -40°C ... +90°C, for cable diameter 4 ... 9 mm, flammability standard UL94-V0											<b>46</b>
	Female electrical plug EN 175301-803-A (DIN 43650-A)/silicone, -40°C ... +125°C, for cable diameter 4 ... 9 mm, flammability standard UL94-V0											<b>56</b>
	Female electrical plug EN 175301-803-A (DIN43650-A)/NBR, -40°C ... +90°C, for cable diameter 4 ... 9.5 mm, flammability standard UL94-V2											<b>58</b>
	Special electrical connection: Pin 1 +, Pin 2 - (only for output signal 4 ... 20 mA and male electrical connector EN175301-803-A/ DIN43650-A)											<b>92</b>
	Special electrical connection: Pin 1 Out, Pin 2 -, Pin 3 + (only for output 0 ... 10 VDC and male electrical connector EN175301-803-A/ DIN43650-A)											<b>98</b>
	Special electrical connection: Pin 1 +, Pin 2 -, Pin 3 Out (only for output 0 ... 10 VDC and male electrical connector EN175301-803-A/ DIN43650-A)											<b>97</b>
	Enhanced condensation protection											<b>CP</b>
	Multiple packaging <sup>5)</sup>											<b>VM</b>

<sup>1)</sup> Customized pressure ranges upon request

<sup>2)</sup> Only for pressure ranges ≥ 0 ... 10 bar

<sup>3)</sup> Upon request

<sup>4)</sup> Not for pressure connection 11

<sup>5)</sup> The order quantity must be a multiple of 50

<sup>6)</sup> Max. allowable pressure range 160 bar at 480 bar overpressure

<sup>7)</sup> Measuring range max. 350 bar according to SAE J1926-3 (Light Duty)

Code	Pressure connection	Seal FPM (Code 61)	Seal EPDM (Code 63)	Seal NBR (Code 83)
17	G1/4" male, Seal: DIN 3869	✓	✓	✓
11	G1/2" male (Manometer) EN 837			
30	1/4" NPT female			
51	1/2" NPT male			
19	R1/4" male, DIN3858			
31	M14x1.5 male DIN EN ISO 6149-2	✓		
61	9/16"-18UNF male, SAE6 (J1926)	✓		

Standard products (extra short lead time)						
Product No.	Type Code	Pressure range [bar]	Over pressure max. [bar]	Signal output	Supply [VDC]	
EPN2.5A	8288 75 2517 05 0000 0000 19 44 58 61	0 ... 2.5	7.5	4 ... 20 mA	9 ... 32	
EPN4.0A	8288 76 2517 05 0000 0000 19 44 58 61	0 ... 4	12	4 ... 20 mA	9 ... 32	
EPN6.0A	8288 77 2517 05 0000 0000 19 44 58 61	0 ... 6	18	4 ... 20 mA	9 ... 32	
EPN10.0A	8288 78 2517 05 0000 0000 19 44 58 61	0 ... 10	30	4 ... 20 mA	9 ... 32	
EPN16.0A	8288 79 2517 05 0000 0000 19 44 58 61	0 ... 16	48	4 ... 20 mA	9 ... 32	
EPN25.0A	8288 80 2517 05 0000 0000 19 44 58 61	0 ... 25	75	4 ... 20 mA	9 ... 32	
EPN40.0A	8288 81 2517 05 0000 0000 19 44 58 61	0 ... 40	120	4 ... 20 mA	9 ... 32	
EPN60.0A	8288 82 2517 05 0000 0000 19 44 58 61	0 ... 60	180	4 ... 20 mA	9 ... 32	
EPN100.0A	8288 83 2517 05 0000 0000 19 44 58 61	0 ... 100	300	4 ... 20 mA	9 ... 32	
EPN160.0A	8288 85 2517 05 0000 0000 19 44 58 61	0 ... 160	480	4 ... 20 mA	9 ... 32	
EPN250.0A	8288 74 2517 05 0000 0000 19 44 58 61	0 ... 250	750	4 ... 20 mA	9 ... 32	
EPN400.0A	8288 84 2517 05 0000 0000 19 44 58 61	0 ... 400	1000	4 ... 20 mA	9 ... 32	
EPN600.0A	8288 86 2517 05 0000 0000 19 44 58 61	0 ... 600	1500	4 ... 20 mA	9 ... 32	

## Specifications

<b>Electrical Data</b>	Output / supply voltage	4 ... 20 mA: 24 (9 ... 32) VDC 0 ... 10 VDC 24 (15 ... 32) VDC
	Rise time	Typ. 1 ms / 10 ... 90 % nominal pressure
	Power-on delay time	100 ms
	Inverse-polarity protection, short-circuit strength @ 25°C during 5 min.	4...20 mA: to $U_s = 32$ VDC 0...10 VDC: to $U_s = 28$ VDC
	<b>Environmental conditions</b>	Media temperature
	Ambient temperature	-40°C ... +125°C
	Protection <sup>1)</sup>	IP65
	Humidity	IEC 60068-2-30 (damp heat, cyclic, 100 % RH @ +55°C)
	Vibration	15 g RMS (20...2000 Hz) acc.to EN 60068-2-64 25 g sin (10...2000 Hz), 1 oct./min, (1x @ 25°C) acc.to EN 60068-2-6
	Shock	500 g / 1 ms acc.to EN 60068-2-27
<b>EMC Protection</b>	Emission	EN/IEC 61000-6-3, IACS UR E10
	Immunity	EN/IEC 61000-6-2, IACS UR E10
<b>Mechanical Data</b>	Sensor (wetted parts)	1.4542 (AISI630)
	Pressure connection (wetted parts)	1.4542 (AISI630) or 1.4404 (AISI316L)
	Housing	1.4542 (AISI630) or 1.4404 (AISI316L)
	Sealing	FPM/EPDM/NBR
	Male electrical connector	See ordering information
	Weight	appr. 80 ... 110 g
	Mounting torque	25 Nm

<sup>1)</sup> See electrical connection

## Accuracy

		<b>Class 0.5 %</b> Ordering No. 25/35	<b>Class 0.3 %</b> Ordering No. 23/33
TEB @ -25 ... +85°C	[% FS typ.]	± 1.75	± 0.5
Accuracy @ +25°C	[% FS typ.]	± 0.5	± 0.3
NLH @ +25°C (BSL)	[% FS typ.]	± 0.2	± 0.1
TC zero point and span	[% FS/K typ.]	± 0.03	± 0.005
Long term stability 1 year @ +25°C	[% FS typ.]	± 0.1	± 0.1

### Class 0.5 %

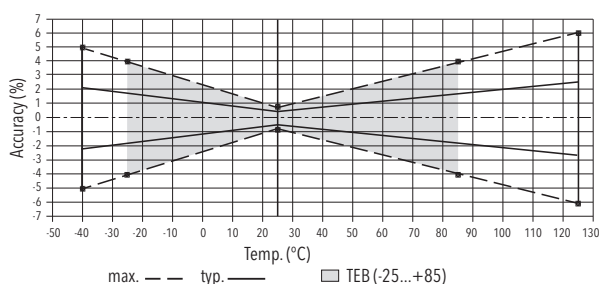

### Class 0.3 %

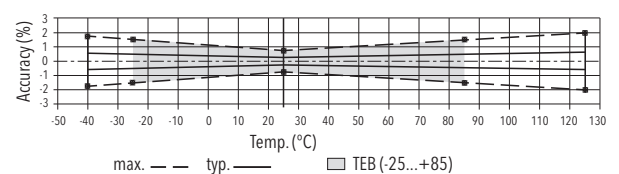

## Dimensions

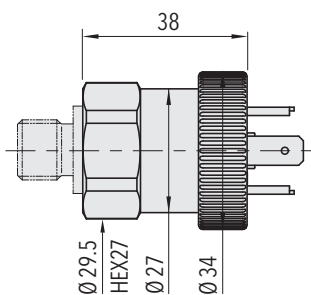

8288.XX.XXXX.05.XX.XX

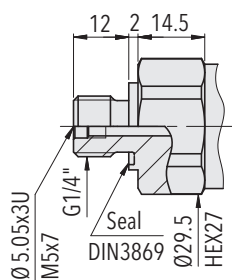

8288.XX.XX17.XX.XX.XX

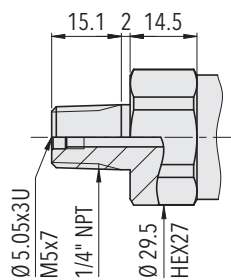

8288.XX.XX30.XX.XX.XX

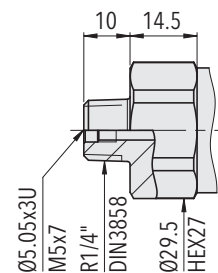

8288.XX.XX19.XX.XX.XX

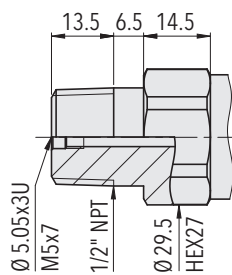

8288.XX.XX51.XX.XX.XX

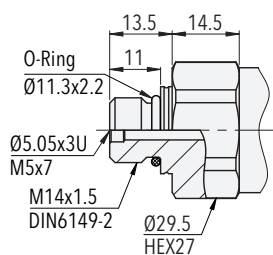

8288.XX.XX31.XX.XX.XX

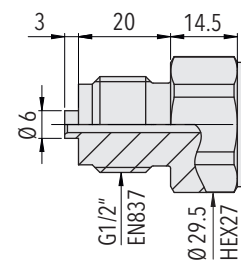

8288.XX.XX11.XX.XX.XX

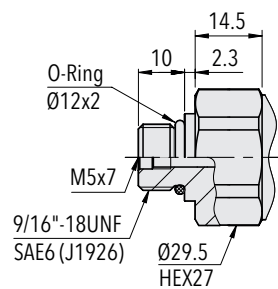

8288.XX.XX61.XX.XX.XX

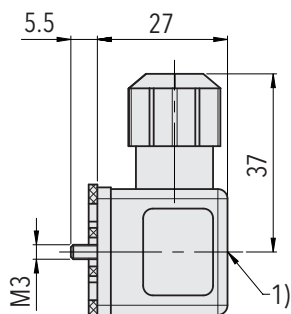

1) Tightening torque 50...60 Ncm

8288.XX.XXXX.XX.XX.46/56

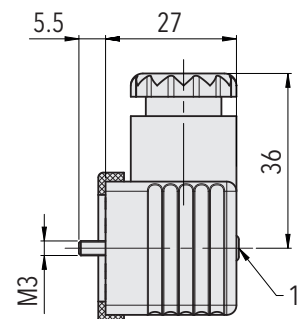

1) Tightening torque 50...60 Ncm

8288.XX.XXXX.XX.XX.58

## Electrical connection

		Protection / electrical connection		
		IP65, IP67*)		
		Industrial standard EN175301-803A **)		
		<b>05</b>		
Output signal	<p><b>8288.xx.xxxx.xx.19</b></p>	Standard		
		2 1 ⊕	<b>92</b> 1 2 ⊕	
Output signal	<p><b>8288.xx.xxxx.xx.17</b></p>	Standard	<b>98</b>	<b>97</b>
		2 3 1 ⊕	3 1 2 ⊕	1 3 2 ⊕

\*) Provided female connector is mounted according to instructions

\*\*) Ventilation via male electric plug

\*\*\*) Only female electrical plug with shield connection

### Additional information

#### Documents

Data sheet	<a href="http://www.trafag.com/H72318">www.trafag.com/H72318</a>
Instructions	<a href="http://www.trafag.com/H73317">www.trafag.com/H73317</a>
Flyer	<a href="http://www.trafag.com/H70693">www.trafag.com/H70693</a>